

PRODUCT DATASHEET

SPOT FP FIX DIM 8 W 3000 K IP65/IP20 WT

SPOT FIREPROOF DIM | Recessed mounted spotlight, round shape, fire-resistant, dimmable



Areas of application

- Replacement of halogen lamp spotlights
- Hotel rooms
- Bars, restaurants
- Bathrooms
- Accent lighting
- Galleries, museums
- General illumination

Product benefits

- High luminous efficacy
- Design matches the LEDVANCE DOWNLIGHT luminaire family
- Energy savings of up to 90 % compared to halogen lamp spotlights
- Functional and minimalistic design
- Easy installation with fast connection
- External driver for extended flexibility (compatible with selected dim. drivers)
- Designed for extra IP protection
- 5 years guarantee

Product features

- Fire-resistant (up to 90 minutes, tested in accordance with EN 1365-2:2014 'fire resistance tests for loadbearing elements - Part 2: Floors and roofs')



- Outdoor use and fire-resistant (up to 90 minutes, BS476-20:1987 and BS476-21:1987)
- Compatible with standard ceiling cutouts of 68 mm
- Initial color consistency: ≤ 4 SDCM
- Type of protection, front side: IP65

TECHNICAL DATA**Electrical data**

Nominal wattage	8.00 W
Nominal voltage	220...240 V
Mains frequency	50...60 Hz
Nominal current	170 mA
Max. no. of lum. on circuit break. B16 A	200
Max. no. of lum. on circuit break. C10 A	100
Max. no. of lum. on circuit break. C16 A	200
Power factor λ	> 0.90
Total harmonic distortion	< 15 %
Protection class	II
Operating mode	Electronic control gear (ECG)

Photometrical data

Luminous flux	620 lm
Luminous efficacy	75 lm/W
Color temperature	3000 K
Light color (designation)	Warm White
Color rendering index Ra	> 80
Standard deviation of color matching	≤ 4 sdcn
Photobiological safety group acc. to EN62778	RG0
Photobiological safety group acc. to EN62471	RG0
Beam angle	36 °

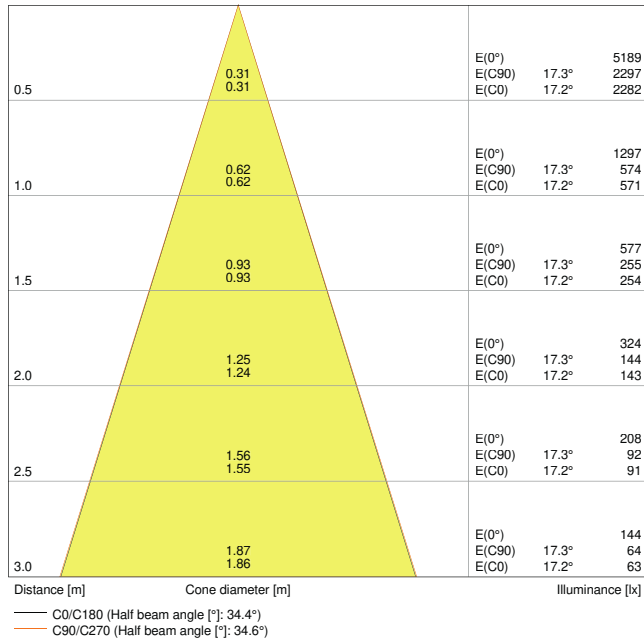

LDC typ cone

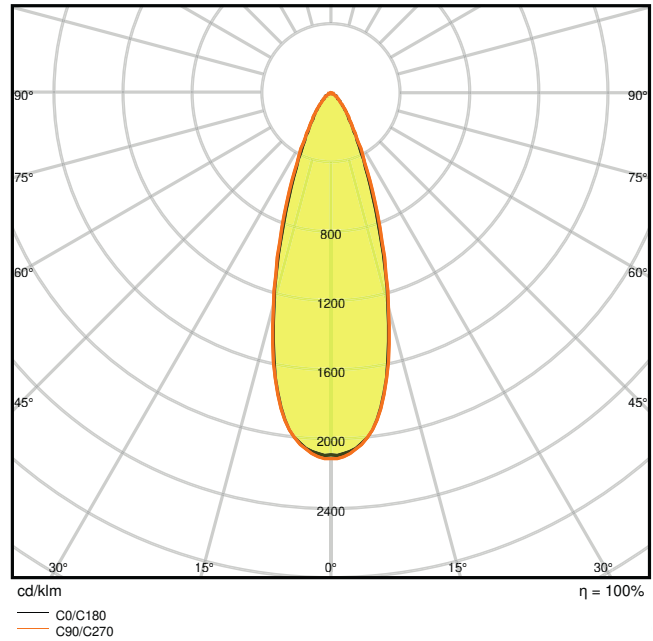

LDC typ polar

Dimensions & Weight

Diameter	81.00 mm
Height	51.00 mm
Product weight	269.00 g

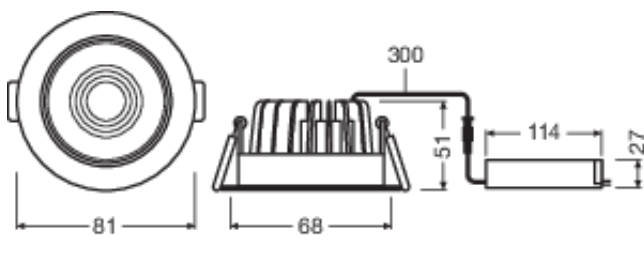

Product line drawing with numbers

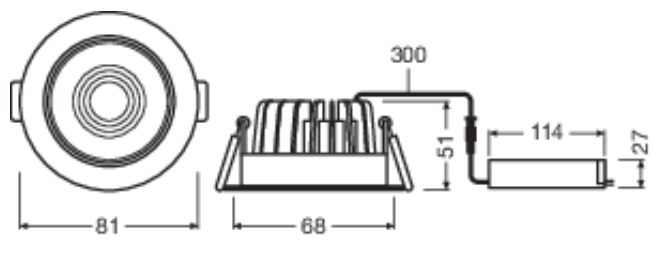

Product line drawing with numbers

Materials & Colors

Product color	White
Housing color	White
Body material	Aluminum
Light emitting surface material	PMMA
Glow Wire Test according to IEC 60695-2-12	650 °C
Mercury content	0.0 mg

Application & Mounting

Ambient temperature range	-20...+45 °C
Type of connection	Screw terminal, 2-Pole (L,N)
Type of protection	IP65/IP20
Protection class IK (shock resistance)	IK06
Dimmable	Yes
Type of dimming	LEA/TR.EDG
Mounting type	Recessed
Mounting location	Ceiling
Application environment	Indoor
Mounting diameter	68 mm
Mounting depth	90 mm
LED module replaceable	Not replaceable
With light source	Yes

Lifespan

Lifespan L70/B50 at 25 °C	50000 h ¹⁾
Lifespan L80/B10 at 25 °C	40000 h ¹⁾
Lifespan L90/B10 at 25 °C	20000 h
Number of switching cycles	100000

¹⁾ t[h]: L70 / B50 @ 25 °C (Ta), t[h]: L80 / B10 @ 25 °C (Ta), t[h]: L90 / B10 @ 25 °C (Ta)

Control gear

ECG - Length	120 mm
ECG - Height	35 mm

Certificates & Standards

Standards	CE / CB / TÜV SÜD / EAC / RoHS
Luminaire with limited surface temperature, "D sign"	No





Ball shot safe	No
----------------	----

Safety advice







- Coordination with your responsible fire safety inspector is required in advance

DOWNLOAD DATA

Documents and certificates

	User instruction
	Addon Technical Information
	On-Pack-Info
	Declarations Of Conformity CE
	Declarations Of Conformity UKCA

Photometric and lighting design files

	IES file (IES)
	LDT file (Eulumdat)
	ULD file (DIALux)
	ROLF file (RELUX)
	UGR file (UGR table)
	LDC typ cone
	LDC typ polar

LOGISTICAL DATA

Product code	Packaging unit (Pieces/Unit)	Dimensions (length x width x height)	Gross weight	Volume
4058075127432	Folding box 1	142 mm x 102 mm x 112 mm	355.00 g	1.62 dm ³

Product code	Packaging unit (Pieces/Unit)	Dimensions (length x width x height)	Gross weight	Volume
4058075190641	Folding box 1	142 mm x 102 mm x 112 mm	355.00 g	1.62 dm ³
4058075190658	Shipping box 27	440 mm x 320 mm x 360 mm	10110.00 g	50.69 dm ³
4058075127449	Shipping box 27	440 mm x 320 mm x 360 mm	10110.00 g	50.69 dm ³

The mentioned product code describes the smallest quantity unit which can be ordered. One shipping unit can contain one or more single products. When placing an order, for the quantity please enter single or multiples of a shipping unit.

ADDITIONAL CATALOG INFORMATION

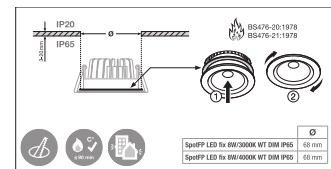
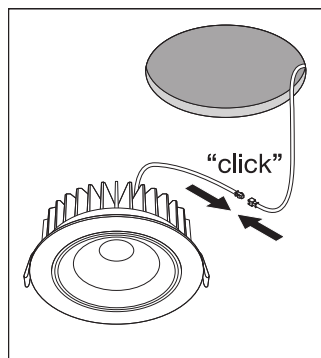
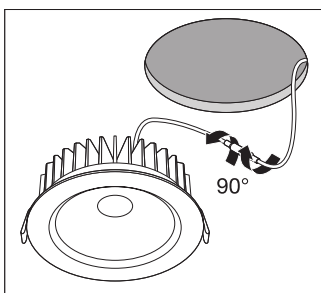

References / Links

- For Guarantee see www.ledvance.com/guarantee

DISCLAIMER

Subject to change without notice. Errors and omission excepted. Always make sure to use the most recent release.