

# EUROLED.LV

EUROPEAN LED COMPANY

## LED LIGHTING CATALOGUE

### LED OFFICE LIGHTING



### LED INDUSTRIAL LIGHTING



### LED STREET LIGHTING



2019-2020

# INFORMATION

EUROLED.LV company was established in 2006. The main focus of the company is a professional LED energy-efficient lighting. Our competitive advantage is a full service cycle, starting with the development and production of new products under the Latvian brand VISIONAL, calculation of lighting projects, delivering and installing the necessary equipment, as well as full warranty and after-warranty service.

EUROLED.LV is an exclusive representative and holder of rights to brand VISIONAL in Europe, China, Russia and USA. Since December 2014, we are authorized dealer of OSRAM, LEDVANCE products.



## LED products VISIONAL:

- The best quality without overpaying
- CE quality certificates, ROHS, as well as high-class energy-saving A ++ energy saving up to 95%
- VISIONAL Premium has a factory warranty – 2-10 years
- Made of environmentally friendly plastic, harmless for human health
- CRI coefficient greater than 80
- Proven reliability and durability

## TABLE OF CONTENTS

LED PANEL OLLO EXCLUSIVE.....	3	LED TRACK LIGHTS .....	35
LED PANEL VISIONAL ONE.....	5	LED GLASS PANELS .....	37
LED PANEL VISIONAL PREMIUM+.....	7	LED SLIM PANELS .....	39
LED PANEL VISIONAL PROFESSIONAL.....	9	LED CEILING LIGHTS .....	41
LED UFO HIGH BAY PREMIUM.....	11	LED CEILING LIGHTS WITH DIAMOND EFFECT.....	43
LED UFO HIGH BAY PROFESSIONAL.....	13	LED PLANT / FITO LIGHTING.....	45
LED HIGH BAY LIGHTS.....	15	LED OUTDOOR LIGHTS .....	47
LED STREET LIGHTS .....	17	ALUMINIUM PROFILE .....	49
LED STREET LIGHTS PREMIUM.....	19	LED BULBS VISIONAL .....	53
LED FLOOD LIGHTS .....	21	LED BULBS FILAMENT VISIONAL.....	57
LED FLOOD LIGHTS PREMIUM .....	23	LED STRIP VISIONAL .....	59
LED FLOOD LIGHTS PROFESSIONAL.....	25	LED CHRISTMAS LIGHTS .....	61
LED TUBES G13/T8 .....	27	LED STRING LIGHTS .....	63
FIXTURES FOR LED T8 .....	29	LED COTTON BALLS.....	65
LED TRI-PROOF LIGHTS .....	31	OUR PROJECTS .....	67
LED LINEAR LIGHTS .....	33	.....	.....

# OUR CUSTOMERS



# LED PANEL OLLO EXCLUSIVE



**OLLO<sup>®</sup>**  
EXCLUSIVE

**LED PANEL LIGHT**

**40W**

NO FLICKERING

**3500 LUMEN**

IP34

3 YEARS FACTORY WARRANTY

BEAM ANGLE **160°**

**CRI 80**

INSTANT FULL LIGHT

PF 0.96

DRIVER INCLUDED

CE RoHS Compliance Recycle EMC compliance

## GENERAL DESCRIPTION

LED PANEL LIGHT OLLO EXCLUSIVE has optimized design for simple mounting and installation. These panel lights can be used in different areas, such as office, commercial place, hotels and etc. LED PANEL LIGHT IIGHT OLLO EXCLUSIVE provides best combination of price and quality. Furthermore, they have instant full light when turning-on, low heat emission and no flickering effect due to high quality materials.

**OLLO**  
EXCLUSIVE

# LED PANEL OLLO EXCLUSIVE



## ACCESSORIES

### 1. Suspension kit



### 2. Surface mounting kit



### 3. Mounting clips



## CONNECTION SCHEME

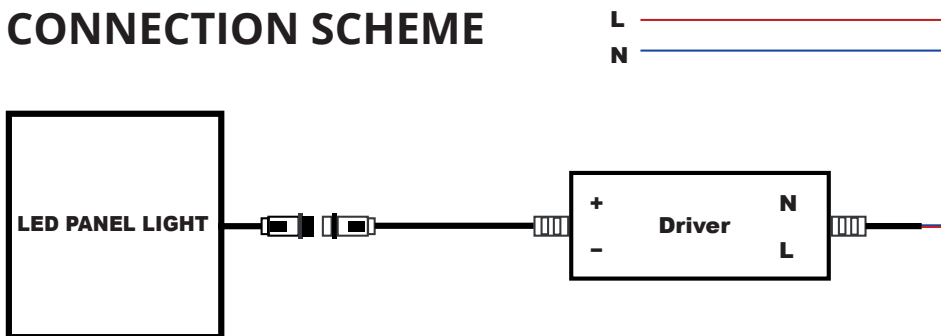

EMC compliance

RoHS



DALI OPTIONAL

## DETAILED DESCRIPTION

POWER JAUDA	40W (40kWh/1000h)	BEAM ANGLE GAISMAS LENĶIS	160°
BRIGHTNESS SPILGTUMS	3500 LUMEN	SIZE IZMĒRS	600x600x 10mm
POWER FACTOR PF KOEFICIENTS	PF ≥ 0.96	DIMMABLE DIMMĒJAMS	OPTIONAL
RA COEFFICIENT RA KOEFICIENTS	CRI ≥ 80	VOLTAGE SPRIEGUMS	110-265V 50/60HZ
POWER SUPPLY EFFICIENCY ENERGOAPGĀDES EFEKTIVĪTĀTE	>90%	PROTECTION LEVEL AIZSARDZĪBAS LĪMENIS	IP 34
LIFETIME KALPOŠANAS ILGUMS	50000 h	TEMPERATURE TEMPERĀTŪRA	-40C - +50C
COLOR TEMPERATURE KRĀSAS TEMPERĀTŪRA	3000K / 4000K	OPTIONAL MODELS CITI MODEĻI	NO

# LED PANEL VISIONAL ONE



**VISIONAL** **LED**  
**ONE**

160°  
BEAM ANGLE

IES FILE IS AVAILABLE

PF ≥ 0.9

CRI ≥ 80

2 YEARS FACTORY WARRANTY

INSTANT FULL LIGHT

NO FLICKERING

DRIVER INCLUDED

50 000 HOURS EXTRA LONG LIFETIME

595x595x10mm DEVELOPED IN EUROPE

**LED PANEL LIGHT**

3000K WARM WHITE    4000K NATURAL WHITE    6000K COLD WHITE

CE RoHS Compliant

**POWER 40W**

BRIGHTNESS **3650 LUMEN**

## GENERAL DESCRIPTION

LED PANEL LIGHT VISIONAL ONE has optimized design for simple mounting and installation. These panel lights can be used in different areas, such as office, commercial place, hotels and etc. LED PANEL LIGHT VISIONAL ONE provides best combination of price and quality. Furthermore, they have instant full light when turning-on, low heat emission and no flickering effect due to high quality materials.

# LED PANEL VISIONAL ONE



## CONNECTION SCHEME

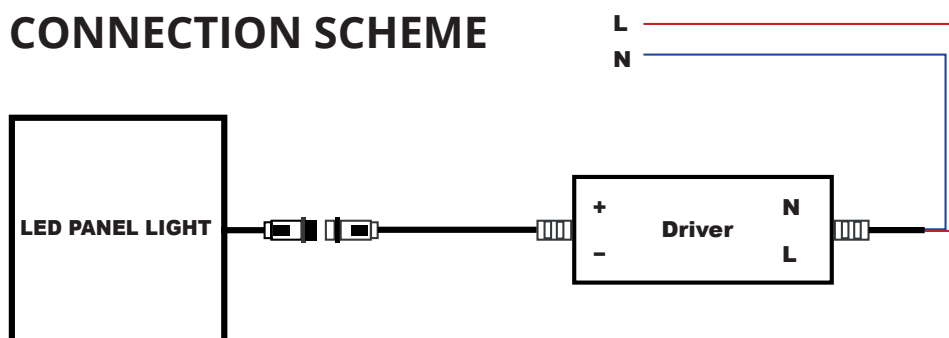

EMC compliance



DALI OPTIONAL

## ACCESSORIES

### 1. Suspension kit



### 2. Surface mounting kit



### 3. Mounting clips



## DETAILED DESCRIPTION

POWER JAUDA	40W (40kWh/1000h)	BEAM ANGLE GAISMAS LENĶIS	160°
BRIGHTNESS SPILGTUMS	3650 LUMEN	SIZE IZMĒRS	595 x 595 x 10mm
POWER FACTOR PF KOEFICIENTS	PF ≥ 0.9	DIMMABLE DIMMĒJAMS	OPTIONAL
RA COEFFICIENT RA KOEFICIENTS	CRI ≥ 80	VOLTAGE SPRIEGUMS	110-265V 50/60HZ
POWER SUPPLY EFFICIENCY ENERGOAPGĀDES EFEKTIVĪTĀTE	>90%	PROTECTION LEVEL AIZSARDZĪBAS LĪMENIS	IP 44
LIFETIME KALPOŠANAS ILGUMS	50000 h	TEMPERATURE TEMPERĀTŪRA	-40C - +50C
COLOR TEMPERATURE KRĀSAS TEMPERĀTŪRA	3000K / 4000K / 6000K	OPTIONAL MODELS CITI MODEĻI	48W (1200 x 300 mm) 72W (1200 x 600 mm)

# LED PANEL VISIONAL PREMIUM+

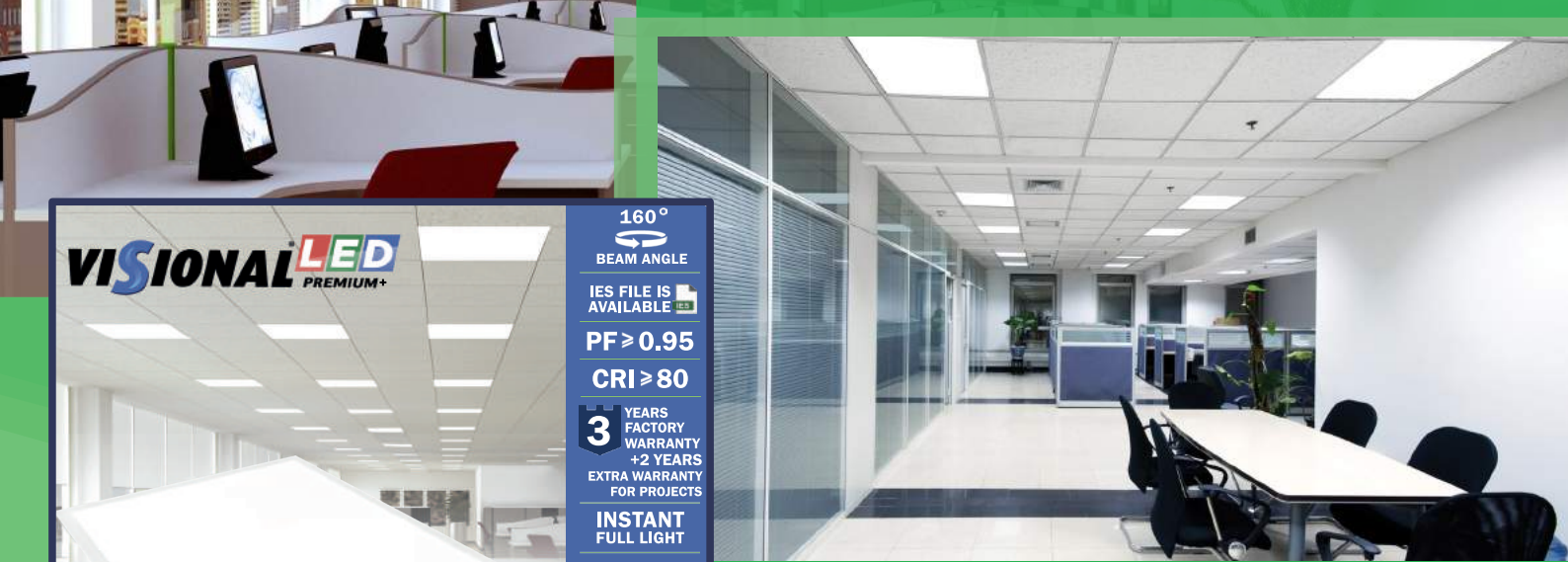

**VISIONAL LED PREMIUM+**

160°  
BEAM ANGLE

IES FILE IS AVAILABLE

PF ≥ 0.95

CRI ≥ 80

3 YEARS FACTORY WARRANTY  
+2 YEARS EXTRA WARRANTY FOR PROJECTS

INSTANT FULL LIGHT

NO FLICKERING

DRIVER INCLUDED

50 000 HOURS EXTRA LONG LIFETIME

595x595x10mm DEVELOPED IN EUROPE

**LED PANEL LIGHT**

3000K WARM WHITE    4000K NATURAL WHITE    6000K COLD WHITE

POWER **40W**

BRIGHTNESS **4400 LUMEN**

CE RoHS CB FC CCC SAA

## GENERAL DESCRIPTION

LED PANEL LIGHT VISIONAL PREMIUM+ is a top product and a best seller of 2017. It is a perfect lighting solution for commercial premises such as offices, factories, retail shops or supermarkets, houses and hotels. LED PANEL LIGHTS VISIONAL PREMIUM+ have extra long lifetime, low energy consumption and have no flickering effect. Moreover, in comparison with other well-known brands LED PANEL LIGHTS VISIONAL PREMIUM+ are much brighter.





# LED PANEL VISIONAL PREMIUM+



EMC compliance TÜV Rheinland CB



DALI OPTIONAL

## INSTALLATION METHODS

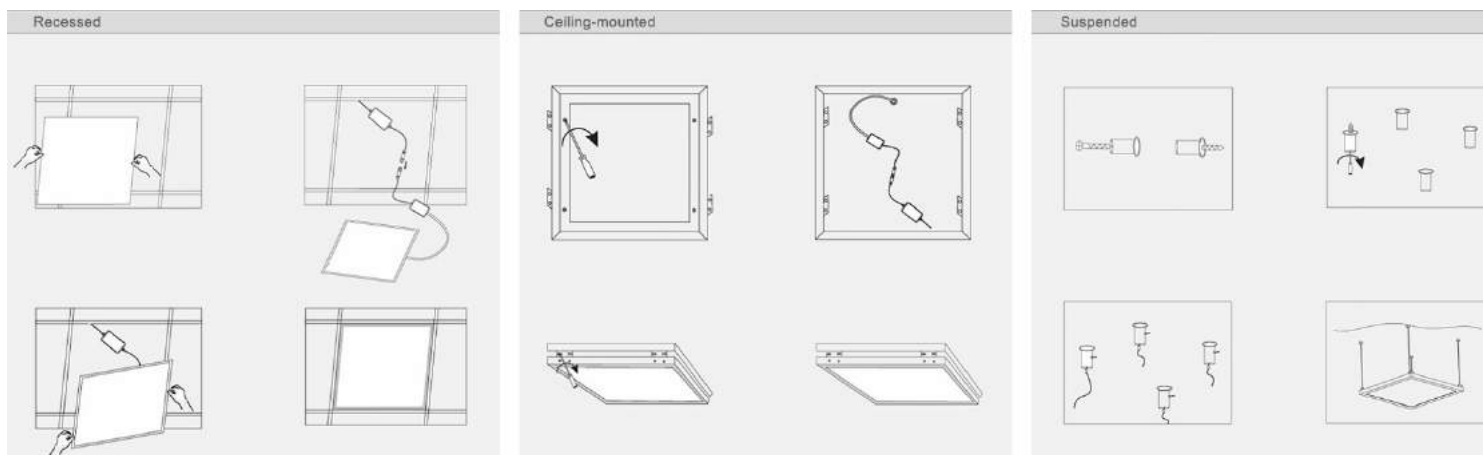

## DETAILED DESCRIPTION

<b>POWER</b> JAUDA	<b>40W (40kWh/1000h)</b>	<b>BEAM ANGLE</b> GAISMAS LENĶIS	<b>160°</b>
<b>BRIGHTNESS</b> SPILGTUMS	<b>4400 LUMEN</b>	<b>SIZE</b> IZMĒRS	<b>595 x 595 x 10mm</b>
<b>POWER FACTOR</b> PF KOEFICIENTS	<b>PF ≥ 0.95</b>	<b>DIMMABLE</b> DIMMĒJAMS	<b>OPTIONAL</b>
<b>RA COEFFICIENT</b> RA KOEFICIENTS	<b>CRI ≥ 80</b>	<b>VOLTAGE</b> SPRIEGUMS	<b>110-265V 50/60HZ</b>
<b>POWER SUPPLY EFFICIENCY</b> ENERGOAPGĀDES EFEKTIVITĀTE	<b>&gt;90%</b>	<b>PROTECTION LEVEL</b> AIZSARDZĪBAS LĪMENIS	<b>IP 44</b>
<b>LIFETIME</b> KALPOŠANAS ILGUMS	<b>50000 h</b>	<b>TEMPERATURE</b> TEMPERATŪRA	<b>-40C - +50C</b>
<b>COLOR TEMPERATURE</b> KRĀSAS TEMPERATŪRA	<b>3000K / 4000K / 6000K</b>	<b>OPTIONAL MODELS</b> CITI MODEĻI	<b>48W (1200 x 300 mm) 72W (1200 x 600 mm)</b>

# LED PANEL VISIONAL PROFESSIONAL



**VISIONAL LED PROFESSIONAL**

160°  
BEAM ANGLE

IES FILE IS AVAILABLE

PF ≥ 0.95

CRI ≥ 80

5 YEARS FACTORY WARRANTY

INSTANT FULL LIGHT

NO FLICKERING

DRIVER INCLUDED

50 000 HOURS EXTRA LONG LIFETIME

UGR 19

595x595x10mm DEVELOPED IN EUROPE

**LED PANEL LIGHT**

3000K WARM WHITE    4000K NATURAL WHITE    6000K COLD WHITE

CE RoHS CB FC CCC

**POWER 40W**

BRIGHTNESS 5600 LUMEN

## GENERAL DESCRIPTION

LED PANEL LIGHT VISIONAL PROFESSIONAL combined modern technologies and classical slim design. Due to advanced technology micro structure light guide plate, which is also called UGR19, these panel lights are brighter than analogues. LED PANEL LIGHT VISIONAL PROFESSIONAL provide high energy-efficiency, extra long lifetime, has no glare-effect and no flickering effect. The ideal light for offices, shopping malls, hotels, hospitals and etc.

**VISIONAL** **LED**  
PROFESSIONAL

# LED PANEL VISIONAL PROFESSIONAL

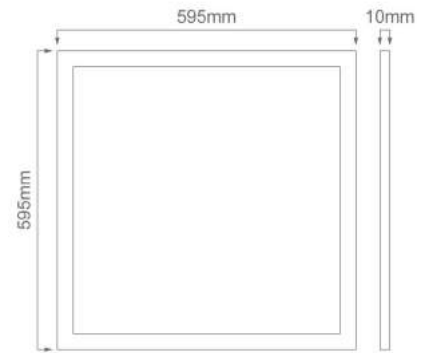

EMC compliance TÜV Rheinland CB



DALI OPTIONAL



## NEW TECHNOLOGY UGR 19 (+50% BRIGHTNESS)



## NO GLARE EFFECT

LED PANEL LIGHT UGR 19  
VISIONAL PROFESSIONAL  
PRISMATIC DIFFUSER



LED PANEL LIGHT  
OF OTHER BRAND  
NORMAL DIFFUSER

NORMAL DIFFUSER

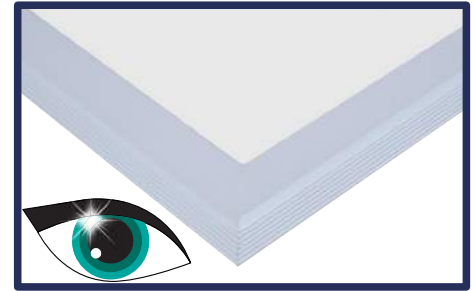

## DETAILED DESCRIPTION

POWER JAUDA	40W (40kWh/1000h)	BEAM ANGLE GAISMAS LEŅĶIS	160°
BRIGHTNESS SPILGTUMS	5600 LUMEN	SIZE IZMĒRS	595 x 595 x 10mm
POWER FACTOR PF KOEFICIENTS	PF ≥ 0.95	DIMMABLE DIMMĒJAMS	OPTIONAL
RA COEFFICIENT RA KOEFICIENTS	CRI ≥ 80	VOLTAGE SPRIEGUMS	110-265V 50/60HZ
POWER SUPPLY EFFICIENCY ENERGOAPGĀDES EFEKTIVITĀTE	>90%	PROTECTION LEVEL AIZSARDZĪBAS LĪMENIS	IP 44
LIFETIME KALPOŠANAS ILGUMS	50000 h	TEMPERATURE TEMPERATŪRA	-40C - +50C
COLOR TEMPERATURE KRĀSAS TEMPERATŪRA	3000K / 4000K / 6000K	OPTIONAL MODELS CITI MODEĻI	48W (1200 x 300 mm) 72W (1200 x 600 mm)

# LED UFO HIGH BAY

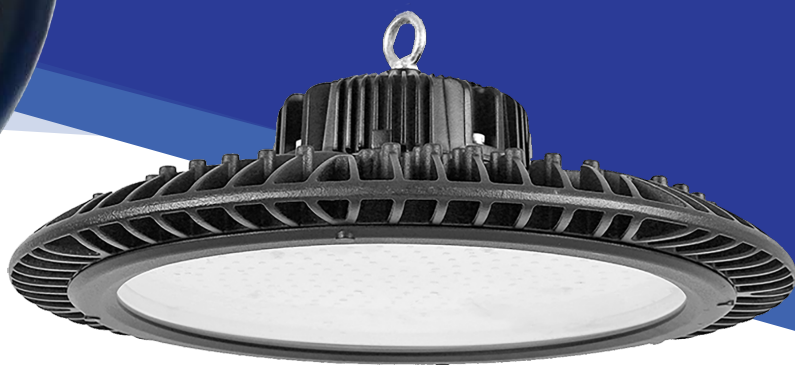

## GENERAL DESCRIPTION

LED UFO HIGH BAY LIGHTS VISIONAL is an excellent replacement of old warehouse lighting. LED UFO lights proved their reliability and durability in many projects. This lighting solution provides instant full light, no flickering and high energy-efficiency. Moreover, dimming features are available. It is perfect lighting solution for industrial areas, warehouses, logistic centers and traffic areas. VISIONAL brand always updates its products, LED UFO lights have improved temperature rating and color quality.

# LED UFO HIGH BAY

PREMIUM LINE

**VISIONAL** LED PREMIUM



LINEAR



MODEL MODELIS	POWER JAUDA	LUMEN OUTPUT GAISMAS PLUSMA	VOLTAGE SPRIEGUMS	LIFETIME KALPOŠANAS ILGUMS	BEAM ANGLE GAISMAS LENKIS	CCT
PREMIUM	100W	12500 Lm	AC 220-240V	50000h	60°/90°/120°	3000K - 6000K
PREMIUM	150W	18750 Lm	AC 220-240V	50000h	60°/90°/120°	3000K - 6000K
PREMIUM	200W	25000 Lm	AC 220-240V	50000h	60°/90°/120°	3000K - 6000K
PREMIUM LINEAR	150W	22500 Lm	AC 85-300V	50000h	60° x 90°	3000K - 6000K

# LED UFO HIGH BAY PROFESSIONAL

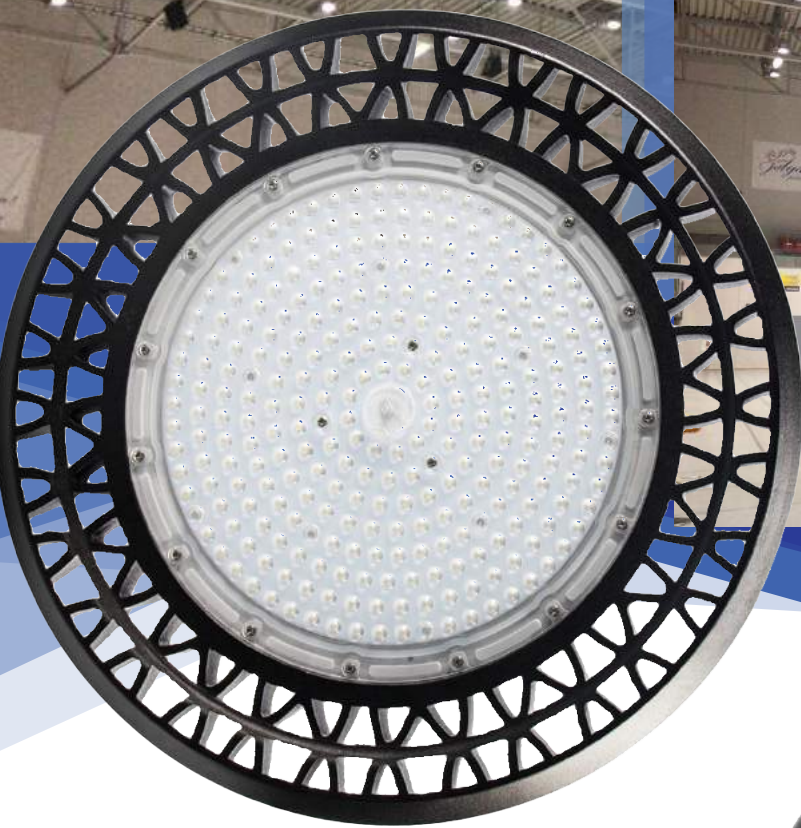

## GENERAL DESCRIPTION

LED UFO HIGH BAY LIGHTS VISIONAL is an excellent replacement of old warehouse lighting. LED UFO lights proved their reliability and durability in many projects. This lighting solution provides instant full light, no flickering and high energy-efficiency. Moreover, dimming features are available. It is perfect lighting solution for industrial areas, warehouses, logistic centers and traffic areas. VISIONAL brand always updates its products, LED UFO lights have improved temperature rating and color quality.

# LED UFO HIGH BAY PROFESSIONAL

**VISIONAL**® **LED** PROFESSIONAL



UFO HIGH BAY WITH PRESENCE SENSOR



- UP TO 5 YEARS FACTORY WARRANTY
- 150 LUMEN/WATT
- PROTECTION LEVEL IP66
- POWER FACTOR >0.95; CRI>80
- BEAM ANGLE 60°/90°/120°
- NO FLICKERING

- UP TO 5 YEARS FACTORY WARRANTY
- 150 LUMEN/WATT
- PROTECTION LEVEL IP66
- POWER FACTOR >0.95; CRI>80
- BEAM ANGLE 60°/ 90°/ 120°
- NO FLICKERING
- LIFUD DRIVER



**LIFUD**®

## MICROWAVE INDUCTION MODULE:

120° CEILING MOUNTING  
 RANGE DETECTION: DIAMETER OF 10 METERS  
 DELAY TIME: 2S/30S/120S/5MIN/15MIN/30MIN  
 BRIGHTNESS 10%-100%

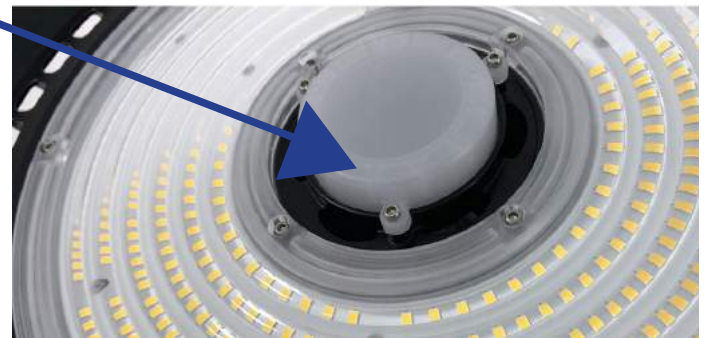

MODEL MODELIS	POWER JAUDA	LUMEN OUTPUT GAISMAS PLUSMA	VOLTAGE SPRIEGUMS	LIFETIME KALPOŠANAS ILGUMS	BEAM ANGLE GAISMAS LENĶIS	CCT
PROFESSIONAL LINE	100W	15000 Lm	AC 220-240V	60000h	60°/90°/120°	3000K - 6000K
PROFESSIONAL LINE	150W	22500 Lm	AC 220-240V	60000h	60°/90°/120°	3000K - 6000K
PROFESSIONAL LINE	200W	30000 Lm	AC 220-240V	60000h	60°/90°/120°	3000K - 6000K
PROFESSIONAL LINE	240W	36000 Lm	AC 85-300V	60000h	60°/90°/120°	3000K - 6000K
PROFESSIONAL LINE / SENSOR	220W	33000 Lm	AC 175-265V	60000h	60°/90°/120°	3000K - 6000K

# LED HIGH BAY LIGHTS



## GENERAL DESCRIPTION

LED HIGH BAY LIGHTS VISIONAL perfectly suit to light a large indoor space like warehouses, manufacturing facilities, factories, and big retail stores. VISIONAL LED high bay lighting is the most energy-efficient option on the market. They offer wide range of illumination angles and mounting height. Moreover, VISIONAL LED HIGH BAY LIGHTS proved their reliability and long-term use for a period up to 20 years.



# LED HIGH BAY LIGHTS

**VISIONAL LED PREMIUM**

**LED HIGH BAY LIGHT**

**100W**

EPISTAR  
LED SMD2835 INSIDE

3 YEARS FACTORY WARRANTY

OPTIONAL

IES FILE AVAILABLE

POWER **100W** BRIGHTNESS **12500lm** COLOR **4000K**

**VISIONAL LED PREMIUM**

**LED HIGH BAY LIGHT**

**150W**

EPISTAR  
LED SMD2835 INSIDE

3 YEARS FACTORY WARRANTY

OPTIONAL

IES FILE AVAILABLE

POWER **150W** BRIGHTNESS **18750lm** COLOR **4000K**

**VISIONAL LED PREMIUM**

**LED HIGH BAY LIGHT**

**200W**

EPISTAR  
LED SMD2835 INSIDE

3 YEARS FACTORY WARRANTY

OPTIONAL

IES FILE AVAILABLE

POWER **200W** BRIGHTNESS **25000lm** COLOR **4000K**

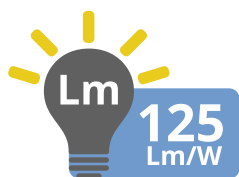

## BEAM ANGLE:

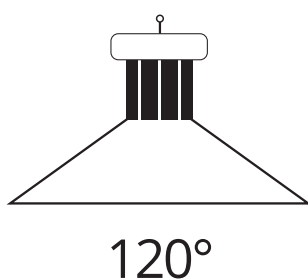
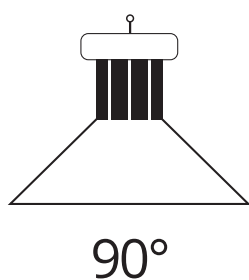
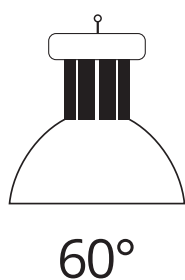

## INSTALLATION HEIGHT:

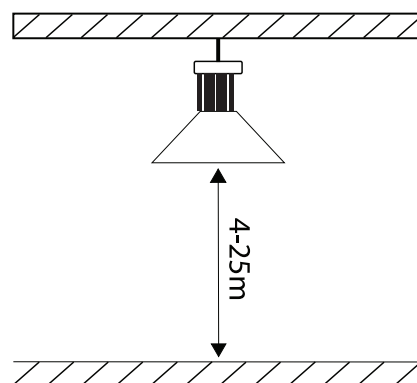

MODEL MODELIS	POWER JAUDA	LUMEN OUTPUT GAISMAS PLUSMA	VOLTAGE SPRIGUMS	LIFETIME KALPOŠANAS ILGUMS	BEAM ANGLE GAISMAS ĻENKIS	CCT	POWER FACTOR KOEFICIENTS PF
PREMIUM	100W	12500 Lm	AC 175-265V	50000h	60°/ 90°/ 120°	4000K	>0.9
PREMIUM	150W	18750 Lm	AC 175-265V	50000h	60°/ 90°/ 120°	4000K	>0.9
PREMIUM	200W	25000 Lm	AC 175-265V	50000h	60°/ 90°/ 120°	4000K	>0.9

# LED STREET LIGHTS BASIC LINE



## GENERAL DESCRIPTION

LED street lights save energy up to 5 times, which in turn reduce the load on electrical network. High lumen output helps to decrease number of car accidents.

Visional ONE Basic LED MODULAR street light are ultimate replacement street light fixtures. It is suitable for high temperature ranges, high dust level and humidity. Visional ONE Basic LED MODULAR street light has been developed to ensure maximum energy efficiency in combination with modern technologies in lighting regulation.

# LED STREET LIGHTS BASIC LINE



- Heat dissipation of the whole structure: The design aims to fully utilize the surface area of structural parts to transfer heat to air. The TJ is lower than 55° C after heat balance
- High Luminous high efficiency and low lumen depreciation
- Using high transparency PMMA lens with many technical patents and light transmittance up to 99%
- Waterproof connectors : free removal to install, simple and quick



- UP TO 3-5 YEARS FACTORY WARRANTY
- UP TO 135 LUMEN/WATT
- PROTECTION LEVEL IP67
- POWER FACTOR >0.95; CRI>80
- BEAM ANGLE 0°-120°

## BEAM ANGLE OPTIONS:



60°



90°



120°

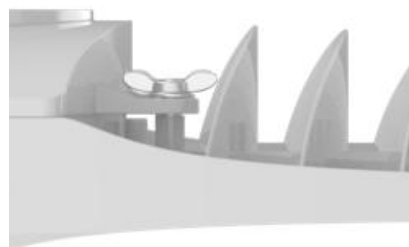
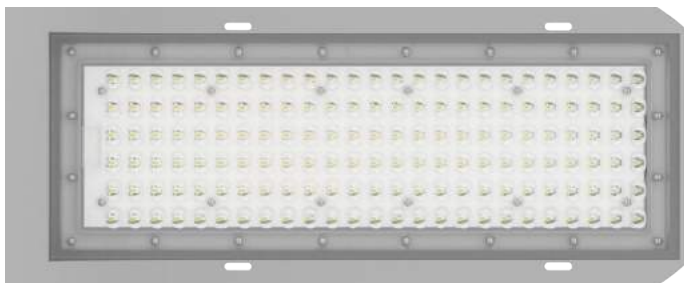

MODEL MODELIS	POWER JAUDA	LUMEN OUTPUT GAISMAS PLUSMA	VOLTAGE SPRIGUMS	LIFETIME KALPOŠANAS ILGUMS	BEAM ANGLE GAISMAS ĻĒNKIS	CCT
BASIC	40W	5400 Lm	AC 100-305V	up to 100000h	60°/ 90°/ 120°	2700K - 6500K
BASIC	60W	8100 Lm	AC 100-305V	up to 100000h	60°/ 90°/ 120°	2700K - 6500K
BASIC	80W	10800 Lm	AC 100-305V	up to 100000h	60°/ 90°/ 120°	2700K - 6500K
BASIC	100W	13500 Lm	AC 100-305V	up to 100000h	60°/ 90°/ 120°	2700K - 6500K
BASIC	120W	16200 Lm	AC 100-305V	up to 100000h	60°/ 90°/ 120°	2700K - 6500K
BASIC	150W	20250 Lm	AC 100-305V	up to 100000h	60°/ 90°/ 120°	2700K - 6500K

# LED STREET LIGHTS PROFESSIONAL



## GENERAL DESCRIPTION

LED STREET LIGHTING VISIONAL is a solution for every successful and modern country. LED street lights save energy up to 5 times, which in turn reduce the load on electrical network. High lumen output helps to decrease number of car accidents. LED STREET LIGHTS VISIONAL proved their reliability and stability in different weather conditions. Factory warranty of VISIONAL street lights is 3-10 years.

# LED STREET LIGHTS PROFESSIONAL



**W** 40W-200W

**Lm** 165 Lm/W

UP TO 7 YEARS FACTORY WARRANTY

IP 67

DIMMABLE

- UP TO 7 YEARS FACTORY WARRANTY
- UP TO 165 LUMEN/WATT
- PROTECTION LEVEL IP67
- POWER FACTOR >0.9; CRI>80
- BEAM ANGLE 150°/65°

## BEAM ANGLE OPTIONS:

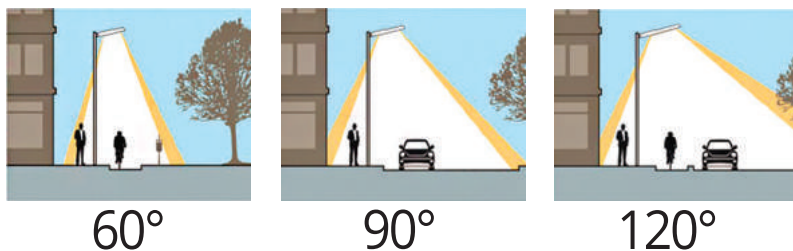

## INSTALLATION

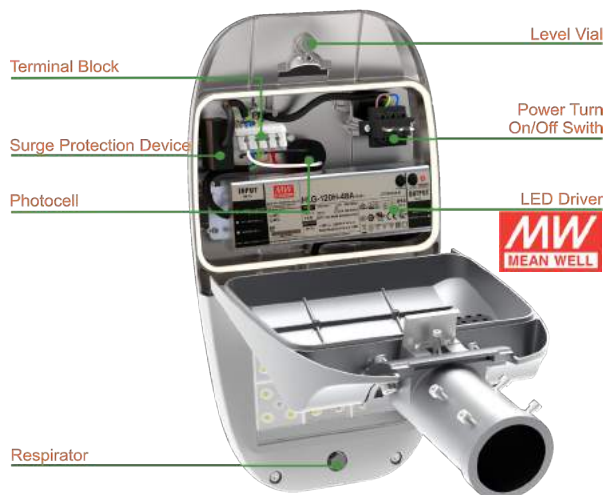
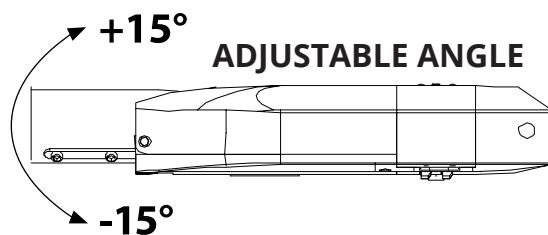

MODEL MODELIS	POWER JAUDA	LUMEN OUTPUT GAISMAS PLUSMA	VOLTAGE SPRIEGUMS	LIFETIME KALPOŠANAS ILGUMS	DIMENSIONS IZMĒRI	CCT
PREMIUM	40W	5200 Lm	AC 100-305V	up to 100000h	370x200 mm	3000K - 6000K
PREMIUM	60W	7800 Lm	AC 100-305V	up to 100000h	495x260 mm	3000K - 6000K
PREMIUM	80W	10400 Lm	AC 100-305V	up to 100000h	490x255 mm	3000K - 6000K
PREMIUM	100W	13000 Lm	AC 100-305V	up to 100000h	495x260 mm	3000K - 6000K
PREMIUM	120W	15600 Lm	AC 100-305V	up to 100000h	495x260 mm	3000K - 6000K
PREMIUM	150W	19500 Lm	AC 100-305V	up to 100000h	615x325 mm	3000K - 6000K
PREMIUM	200W	26000 Lm	AC 100-305V	up to 100000h	615x325 mm	3000K - 6000K

# LED FLOOD LIGHTS BASIC LINE



## GENERAL DESCRIPTION

LED FLOOD LIGHTS VISIONAL is a perfect lighting solution for commercial and industrial outdoor areas. VISIONAL FLOOD LIGHTS provide good color rendering and instant start-up for higher security. High-quality materials combined with a stylish and compact design made LED FLOOD LIGHTS VISIONAL very popular on the market, due to their high-intensity, high IP protection and high energy-efficiency up to 80%.



# LED FLOOD LIGHTS BASIC LINE

**VISIONAL** **LED**  
ONE



## INSTALLATION METHODS

1

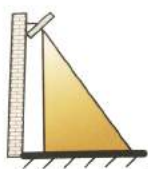

Wall-mounted  
(Area Floodlight)

2

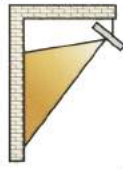

Canopy-mounted  
(Shops Facade Floodlight)

3



Arm-mounted  
(Signvue Uplight)

4



Arm-mounted  
(Signvue Downlight)

5



Wall-mounted  
(Tunnel lighting)

6



Pole-mounted  
(Parking lots)

7



Suspend-mounted  
(Baylight High / Low)

8



On the ground  
(Landscape lighting)

POWER JAUDA	BEAM ANGLE	LUMEN OUTPUT GAISMAS PLUSMA	VOLTAGE SPRIEGUMS	LIFETIME KALPOŠANAS ILGUMS	DIMENSIONS IZMĒRI	CCT	DRIVER BAROŠANAS BLOKS
10W	120°	1000 Lm	AC 100-240V	50000h	130x110x50 mm	3000K - 6000K	MEANWELL
20W	120°	2000 Lm	AC 100-240V	50000h	175x156x57 mm	3000K - 6000K	MEANWELL
30W	120°	3000 Lm	AC 100-240V	50000h	192x171x59 mm	3000K - 6000K	MEANWELL
50W	120°	6000 Lm	AC 100-240V	50000h	235x200x66 mm	3000K - 6000K	MEANWELL
80W	120°	8000 Lm	AC 100-240V	50000h	285x250x70 mm	3000K - 6000K	MEANWELL
100W	120°	10000 Lm	AC 100-240V	50000h	285x250x70 mm	3000K - 6000K	MEANWELL
150W	120°	15000 Lm	AC 100-240V	50000h	360x300x90 mm	3000K - 6000K	MEANWELL
200W	120°	20000 Lm	AC 100-240V	50000h	500x380x115 mm	3000K - 6000K	MEANWELL
300W	120°	30000 Lm	AC 100-240V	50000h	500x380x115 mm	3000K - 6000K	MEANWELL
400W	120°	40000 Lm	AC 100-240V	50000h	500x380x115 mm	3000K - 6000K	MEANWELL

# LED FLOOD LIGHTS PREMIUM



## GENERAL DESCRIPTION

LED FLOOD LIGHTS are high-intensity artificial lights with high IP protection. Its often used to illuminate outdoor, or commercial areas. LED FLOOD LIGHTS are known for their durability and energy efficient that is 70% of energy saving. Usually, they are used in playing fields, car parkings, landscapes lightening and other outdoor areas.



# LED FLOOD LIGHTS PREMIUM

## FLOOD LIGHTS VISIONAL PREMIUM



- BEAM ANGLE 70°
- UP TO 120 LUMEN/WATT
- PROTECTION LEVEL IP66
- RA COEFFICIENT - CRI>80
- LIFESPAN 50000 HOURS

- BEAM ANGLE 120°
- UP TO 120 LUMEN/WATT
- PROTECTION LEVEL IP66
- RA COEFFICIENT - CRI 80
- LIFESPAN 50000 HOURS

MODEL MODELIS	POWER JAUDA	LUMEN OUTPUT GAISMAS PLUSMA	VOLTAGE SPRIEGUMS	LIFETIME KALPOŠANAS ILGUMS	DIMENSIONS IZMĒRI	CCT
VS-FL50W / 70° BLACK	50W	6000 Lm	AC 175-265V	50000h	160x40x200 mm	4000K
VS-FL50W / 120° BLACK	50W	6000 Lm	AC 175-265V	50000h	160x40x200 mm	4000K
VS-FL50W / 120° GREY	50W	6000 Lm	AC 175-265V	50000h	160x40x200 mm	4000K
VS-FL100W / 70° BLACK	100W	12000 Lm	AC 175-265V	50000h	210x50x260 mm	4000K
VS-FL100W / 120° BLACK	100W	12000 Lm	AC 175-265V	50000h	210x50x260 mm	4000K
VS-FL100W / 120° GREY	100W	12000 Lm	AC 175-265V	50000h	210x50x260 mm	4000K
VS-FL150W / 70° BLACK	150W	18000 Lm	AC 175-265V	50000h	295x50x360 mm	4000K
VS-FL150W / 120° BLACK	150W	18000 Lm	AC 175-265V	50000h	295x50x360 mm	4000K
VS-FL150W / 120° GREY	150W	18000 Lm	AC 175-265V	50000h	295x50x360 mm	4000K
VS-FL200W / 70° BLACK	200W	24000 Lm	AC 175-265V	50000h	295x50x360 mm	4000K
VS-FL200W / 120° BLACK	200W	24000 Lm	AC 175-265V	50000h	295x50x360 mm	4000K
VS-FL200W / 120° GREY	200W	24000 Lm	AC 175-265V	50000h	295x50x360 mm	4000K

# LED FLOOD LIGHTS PROFESSIONAL



## GENERAL DESCRIPTION

LED FLOOD LIGHTS VISIONAL is a perfect lighting solution for commercial and industrial outdoor areas. VISIONAL FLOOD LIGHTS provide good color rendering and instant start-up for higher security. High-quality materials combined with a stylish and compact design made LED FLOOD LIGHTS VISIONAL very popular on the market, due to their high-intensity, high IP protection and high energy-efficiency up to 80%.

# LED FLOOD LIGHTS PROFESSIONAL

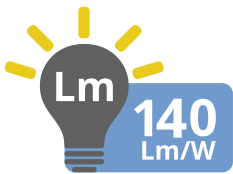

## INSTALLATION METHODS

1

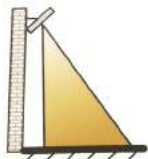

Wall-mounted  
(Area Floodlight)

2

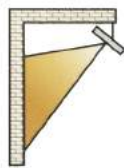

Canopy-mounted  
(Shops Facade Floodlight)

3



Arm-mounted  
(Signvue Uplight)

4



Arm-mounted  
(Signvue Downlight)

5



Wall-mounted  
(Tunnel lighting)

6



Pole-mounted  
(Parking lots)

7



Suspend-mounted  
(Baylight High / Low)

8



On the ground  
(Landscape lighting)

POWER JAUDA	LED TYPE LED TIPS	LUMEN OUTPUT GAISMAS PLUSMA	VOLTAGE SPRIEGUMS	LIFETIME KALPOŠANAS ILGUMS	DIMENSIONS IZMĒRI	CCT	DRIVER BAROŠANAS BLOKS
10W	OSRAM 3030	1300 Lm	AC 100-240V	50000h	130x110x50 mm	3000K - 6000K	TUV
20W	OSRAM 3030	2600 Lm	AC 100-240V	50000h	175x156x57 mm	3000K - 6000K	TUV
30W	OSRAM 3030	3900 Lm	AC 100-240V	50000h	192x171x59 mm	3000K - 6000K	TUV
50W	OSRAM 3030	6500 Lm	AC 100-240V	50000h	235x200x66 mm	3000K - 6000K	TUV
80W	OSRAM 3030	10400 Lm	AC 100-240V	50000h	285x250x70 mm	3000K - 6000K	TUV
100W	OSRAM 3030	13000 Lm	AC 100-240V	50000h	285x250x70 mm	3000K - 6000K	MEANWELL
150W	OSRAM 3030	19500 Lm	AC 100-240V	50000h	360x300x90 mm	3000K - 6000K	MEANWELL
200W	OSRAM 3030	26000 Lm	AC 100-240V	50000h	500x380x115mm	3000K - 6000K	MEANWELL

# LED TUBES G13/T8



German Technology 

## GENERAL DESCRIPTION

LED TUBES G13 / T8 VISIONAL is a perfect replacement of standard fluorescent lamps. LED T8 bulbs VISIONAL provides instant full light, no flickering, high energy-efficiency and great brightness output. It is rather popular lighting solutions for schools, offices, hospitals, shops and small industrial areas, as they can be easily and safely installed. Moreover, VISIONAL offers two lines of products VISIONAL PREMIUM and VISIONAL ONE which can meet all preferences and needs of the user.

**VISIONAL**  **ONE**

**VISIONAL**  **PREMIUM**

# LED TUBES G13/T8

## German Technology

### BASIC LINE

**VISIONAL LED ONE**



- UP TO 2 YEARS FACTORY WARRANTY
- UP TO 90 LUMEN/WATT
- PROTECTION LEVEL IP40
- RA COEFFICIENT CRI80
- LIFETIME UP TO 30000 h.
- LOW PRICES

### PREMIUM LINE

**VISIONAL LED PREMIUM**



- UP TO 3 YEARS FACTORY WARRANTY
- UP TO 110 LUMEN/WATT
- PROTECTION LEVEL IP40
- RA COEFFICIENT CRI>80
- LIFETIME UP TO 30000 h.
- HIGH QUALITY LED / DRIVER



RoHS CE



## CONNECTION TYPES:



MODEL MODELIS	POWER JAUDA	LUMEN GAISMAS PLUSMA	VOLTAGE SPRIEGUMS	BEAM ANGLE GAISMAS LENĶIS	DIMENSIONS IZMĒRI	CCT
PREMIUM 60cm	10W	1100 Lm	AC 170-265V	180°	600mm	3000K - 6000K
PREMIUM 120cm	18W	1980 Lm	AC 170-265V	180°	1200mm	3000K - 6000K
PREMIUM 150cm	24W	2640 Lm	AC 170-265V	180°	1500mm	3000K - 6000K
BASIC 60cm	10W	900 Lm	AC 170-265V	200°	600mm	3000K - 6000K
BASIC 120cm	18W	1620 Lm	AC 170-265V	200°	1200mm	3000K - 6000K
BASIC 150cm	24W	2160 Lm	AC 170-265V	200°	1500mm	3000K - 6000K

# FIXTURES FOR LED T8



## GENERAL DESCRIPTION

FIXTURES FOR LED T8 TUBE LIGHTS VISIONAL protect lamps from moisture, dust, and mechanical damages, which helps to extend the lifetime of T8 tubes significantly. Extra clear transparent glass increase the brightness by 10%. Stainless steel clips and other metal accessories are another distinctive benefits of VISIONAL fixtures. They are used for lighting in schools, hospitals, parking garages, factories and etc.

# FIXTURES FOR LED T8

**VISIONAL<sup>®</sup> LED**  
PREMIUM



IP  
20



SUSPENSION  
KIT AVAILABLE



STAINLESS  
STEEL CLIPS



IP  
65



x2 LED T8 / G13  
TUBES 1500mm



## DIMENSIONS

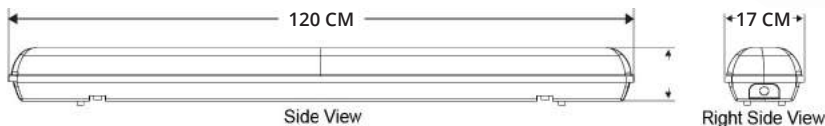

120 CM  
150 CM



## DETAILED DESCRIPTION

PROTECTION LEVEL AIZSARDĪBAS LĪMENIS	IP20/IP65
PRODUCT MATERIAL PRODUKTA MATERIĀLS	PLASTIC/METAL
CLIPS KLIPI	STAINLESS STEEL
LED BULBS T8 (G13) LED SPULDZES T8 (G13)	2/1 BULBS
BALLAST BAROŠANAS BLOKS	NO
DIMENSIONS IZMĒRI	120 x 17cm/150 x 17cm

## DIMENSIONS

- METAL CLIPS
- EASY TO INSTALL
- +10% BRIGHTNESS
- TRANSPARENT GLASS
- HIGH PROTECTION LEVEL
- DIFFERENT INSTALLATION METHODS AVAILABLE

# LED TRI-PROOF LIGHTS



## GENERAL DESCRIPTION

LED TRI-PROOF LIGHTS VISIONAL are well-known for their energy efficiency, that saves about 60% of energy. Moreover, linear lights has simple and various installation methods, they can be suspended or surface-mounted. Its sleek and slim design is unobtrusive and allows integration into any design aesthetic. LED TRI-PROOF LIGHTS VISIONAL are perfect for offices, factories, stocks, car parking, shops and etc.



# LED TRI-PROOF LIGHTS

## PROFESSIONAL LINE



- UP TO 5 YEARS FACTORY WARRANTY
- UP TO 110 LUMEN/WATT
- PROTECTION LEVEL IP34
- RA COEFFICIENT CRI 80
- LIFETIME UP TO 50000 h.

## PROFESSIONAL LINE



- UP TO 5 YEARS FACTORY WARRANTY
- UP TO 110 LUMEN/WATT
- PROTECTION LEVEL IP65
- RA COEFFICIENT CRI 83
- POWER FACTOR PF 0.97



## METAL CLIPS IN SET



## SUSPENDED TRI-PROOF LIGHT



MODEL MODELIS	POWER JAUDA	LUMEN OUTPUT GAISMAS PLUSMA	VOLTAGE SPRIEGUMS	LIFETIME KALPOŠANAS ILGUMS	DIMENSIONS IZMĒRI	CCT
PREMIUM 60CM	18W	1980 Lm	AC 170-265V	50000h	600 x 25 mm	3000K - 6000K
PREMIUM 120CM	36W	3960 Lm	AC 170-265V	50000h	1200 x 25 mm	3000K - 6000K
PREMIUM 150CM	45W	4950 Lm	AC 170-265V	50000h	1500 x 25 mm	3000K - 6000K
PREMIUM 180CM	60W	1980 Lm	AC 170-265V	50000h	1800 x 25 mm	3000K - 6000K
PREMIUM 120CM	36W	3960 Lm	AC 170-265V	up to 100000h	1200 x 50 mm	3000K - 6000K
PREMIUM 150CM	45W	4950 Lm	AC 170-265V	up to 100000h	1500 x 50 mm	3000K - 6000K
PREMIUM 150CM	70W	7700 Lm	AC 170-265V	up to 100000h	1500 x 50 mm	3000K - 6000K

# LED LINEAR LIGHTS



## GENERAL DESCRIPTION

LED LINEAR LIGHTING fixtures designed for office and home lighting. This energy-efficient lighting solutions easily create unique fashion design and modern atmosphere. Different installation methods and lighting modes provide opportunity to light any object or surface. Furthermore, LED LINEAR LIGHTS VISIONAL have high lumen output, long lifetime, due to high quality materials.

# LED LINEAR LIGHTS

## LED LINEAR SERIES VSL703

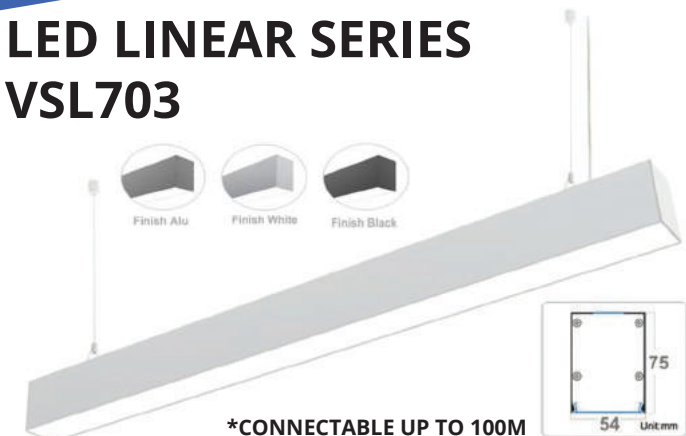

## LED LINEAR SERIES VSL704

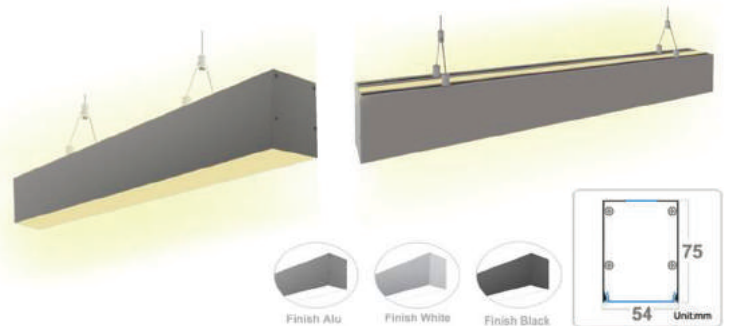

## LED LINEAR SERIES VSL712

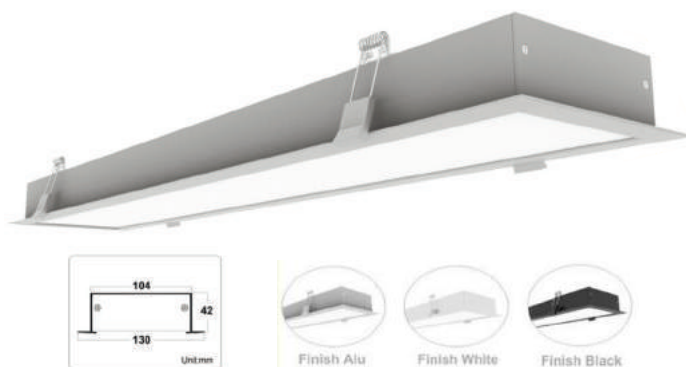

## LED LINEAR SERIES VSL708 UGR<17



MODEL MODELIS	POWER JAUDA	CCT	LUMEN OUTPUT GAISMAS PLUSMA	VOLTAGE SPRIEGUMS	BEAM ANGLE GAISMAS LENĶIS
VSL703-20W 89CM 20W	20W	2800/4000/6000K	1900 - 2650 Lm	AC 110-240V	120°
VSL703-40W 119CM 40W	40W	2800/4000/6000K	3700 - 5200 Lm	AC 110-240V	120°
VSL703-60W 149CM 60W	60W	2800/4000/6000K	5500 - 7800 Lm	AC 110-240V	120°
VSL704-32W 89CM 32W	32W	2800/4000/6000K	3000/3150/3200 Lm	AC 110-240V	120°
VSL704-50W 119CM 50W	50W	2800/4000/6000K	4500/4670/4690 Lm	AC 110-240V	120°
VSL704-70W 149CM 70W	70W	2800/4000/6000K	6490/6570/6590 Lm	AC 110-240V	120°
VSL708-30W 118CM 30W	30W	2800/4000/6000K	3020/3200/3350 Lm	AC 110-240V	360°
VSL708-40W 118CM 40W	40W	2800/4000/6000K	4160/4300/4400 Lm	AC 110-240V	360°
VSL708-50W 118CM 50W	50W	2800/4000/6000K	5180/5350/5500 Lm	AC 110-240V	360°
VSL708-60W 118CM 60W	60W	2800/4000/6000K	6180/6400/6550 Lm	AC 110-240V	360°
VSL712-20W 33CM 20W	20W	2800/4000/6000K	1800/1900/1960 Lm	AC 110-240V	120°
VSL712-30W 62CM 30W	30W	2800/4000/6000K	2700/2850/2900 Lm	AC 110-240V	120°
VSL712-40W 62CM 40W	40W	2800/4000/6000K	3600/3850/3900 Lm	AC 110-240V	120°
VSL712-40W 93CM 40W	40W	2800/4000/6000K	3620/3850/3920 Lm	AC 110-240V	120°
VSL712-45W 121CM 45W	45W	2800/4000/6000K	3620/3850/3920 Lm	AC 110-240V	120°
VSL712-60W 149CM 60W	60W	2800/4000/6000K	5540/5800/5900 Lm	AC 110-240V	120°

# LED TRACK LIGHTS



## GENERAL DESCRIPTION

LED TRACK LIGHTS VISIONAL is a modern and stylish lighting solution for shops, museums, art shops and other areas where the accent lighting is needed. Furthermore, VISIONAL track lights provide energy-efficiency, long life ranging, instant full light and high lumen output. LED TRACK LIGHTS VISIONAL create unique lighting design, due to options of dimmable LEDs.

# LED TRACK LIGHTS

**VISIONAL**® **LED**  
PROFESSIONAL

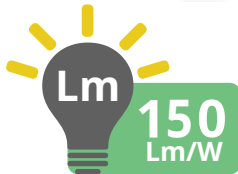

## ACCESSORIES:



MODEL MODELIS	POWER JAUDA	LUMEN GAISMAS PLUSMA	VOLTAGE SPRIEGUMS	BEAM ANGLE GAISMAS LEŅĶIS	HOUSING COLOR KORPUSA KRĀSA	CCT
VISIONAL ONE	20W	1600 Lm	AC 100-240V	24°/30°/36°/40°/45°/60°	WHITE/BLACK/SILVER	2700K - 6500K
VISIONAL ONE	28W	2240 Lm	AC 100-240V	24°/30°/36°/40°/45°/60°	WHITE/BLACK/SILVER	2700K - 6500K
PREMIUM	30W	3000 Lm	AC 100-240V	24°/30°/36°/40°/45°/60°	WHITE/BLACK/SILVER	2700K - 6500K
PREMIUM	35W	3500 Lm	AC 220-240V	24°/30°/36°/40°/45°/60°	WHITE/BLACK/SILVER	2700K - 6500K
BASIC+ REMOTE CONTROL	30W	3000 Lm	AC 220-240V	24°/30°/36°/40°/45°/60°	WHITE/BLACK/SILVER	2700K - 6500K
BASIC + PINK	30W	3000 Lm	AC 220-240V	24°/30°/36°/40°/45°/60°	WHITE/BLACK/SILVER	2700K - 6500K
BASIC+ DIMABLE CONTROL	30W	3900 Lm	AC 220-240V	24°/30°/36°/40°/45°/60°	WHITE/BLACK/SILVER	2700K - 6500K

# LED GLASS PANELS



## GENERAL DESCRIPTION

LED GLASS PANEL LIGHT VISIONAL has modern and stylish design. Slim glass outer ring creates the double light effect at the sides, that makes it even more elegant. In addition these panel lights provide energy-efficiency and high lumen output. LED GLASS PANEL LIGHT VISIONAL has no-flickering effect and long life ranging. It perfectly suits to flats, offices, shops, hotels and homes.

# LED GLASS PANELS

**VISIONAL LED PREMIUM**



EXTRA BRIGHT  
**600 LM**

**CRI > 80**

**120°**  
BEAM ANGLE

INSTANT FULL LIGHT

LOW HEAT EMISSION

IES FILE AVAILABLE

NO FLICKERING

50 000 HOURS EXTRA LONG LIFE

**LED GLASS PANEL 6W**  
DEVELOPED IN EUROPE

3 YEARS FACTORY WARRANTY

LED 6W = 50W

CE RoHS ErP

SUITABLE FOR PROJECTS

**VISIONAL LED PREMIUM**



EXTRA BRIGHT  
**1200 LM**

**CRI > 80**

**120°**  
BEAM ANGLE

INSTANT FULL LIGHT

LOW HEAT EMISSION

IES FILE AVAILABLE

NO FLICKERING

50 000 HOURS EXTRA LONG LIFE

**LED GLASS PANEL 12W**  
DEVELOPED IN EUROPE

3 YEARS FACTORY WARRANTY

LED 12W = 100W

CE RoHS ErP

SUITABLE FOR PROJECTS

**VISIONAL LED PREMIUM**



EXTRA BRIGHT  
**1800 LM**

**CRI > 80**

**120°**  
BEAM ANGLE

INSTANT FULL LIGHT

LOW HEAT EMISSION

IES FILE AVAILABLE

NO FLICKERING

50 000 HOURS EXTRA LONG LIFE

**LED GLASS PANEL 18W**  
DEVELOPED IN EUROPE

3 YEARS FACTORY WARRANTY

LED 18W = 150W

CE RoHS ErP

SUITABLE FOR PROJECTS



## Easy to install and use

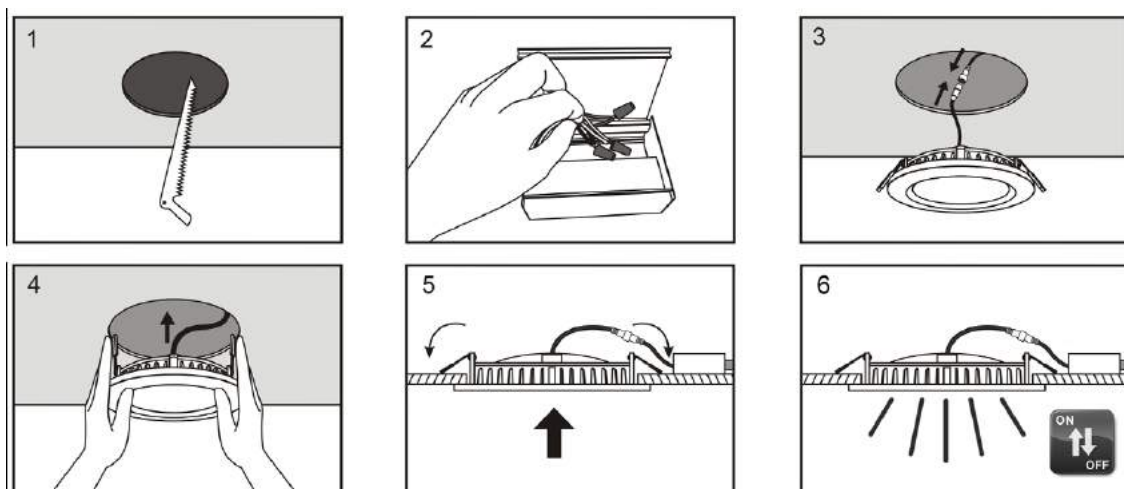

MODEL MODELIS	POWER JAUDA	LUMEN GAISMAS PLUSMA	VOLTAGE SPRIEGUMS	BEAM ANGLE GAISMAS LENĶIS	DIMENSIONS IZMĒRI	CCT
Round panel	6W	600 Lm	AC 85-265V	120°	Ø 100 x 35mm	3000K - 6000K
Round panel	12W	1200 Lm	AC 85-265V	120°	Ø 160 x 35mm	3000K - 6000K
Round panel	18W	1800 Lm	AC 85-265V	120°	Ø 200 x 35mm	3000K - 6000K
Round panel	27W	2700 Lm	AC 85-265V	120°	Ø 260 x 30mm	3000K - 6000K
Square panel	6W	600 Lm	AC 85-265V	120°	100x100x35mm	3000K - 6000K
Square panel	12W	1200 Lm	AC 85-265V	120°	160x160x35mm	3000K - 6000K
Square panel	18W	1800 Lm	AC 85-265V	120°	200x200x35mm	3000K - 6000K
Square panel	27W	2700 Lm	AC 85-265V	120°	260x260x30mm	3000K - 6000K

# LED SLIM PANELS



## GENERAL DESCRIPTION

One of the main benefits of LED SLIM PANEL LIGHTS VISIONAL is contemporary and elegant slim design. Furthermore, they are very profitable in use, as LED slim panels save up to 80% energy. LED SLIM PANEL LIGHTS VISIONAL has no - flickering effect and low heat emission. It is modern and refined lighting solution to offices, shops, hotels and homes.



# LED SLIM PANELS



## DIMENSIONS:

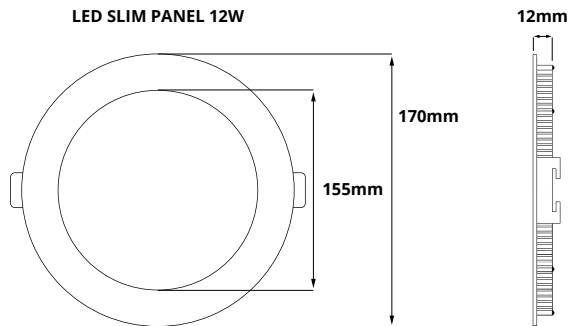

## INSTALLATION:

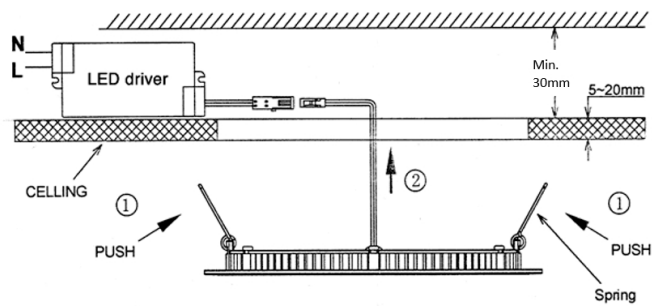

MODEL MODELIS	POWER JAUDA	LUMEN GAISMAS PLUSMA	VOLTAGE SPRIEGUMS	BEAM ANGLE GAISMAS LENĶIS	DIMENSIONS IZMĒRI	CCT
ROUND PANEL	3W	300 Lm	AC 90-265V	120°	ø 85 x 12mm	3000K - 5000K
ROUND PANEL	6W	600 Lm	AC 90-265V	120°	ø 120 x 12mm	3000K - 5000K
ROUND PANEL	12W	1200 Lm	AC 90-265V	120°	ø 170 x 12mm	3000K - 5000K
ROUND PANEL	18W	1800 Lm	AC 90-265V	120°	ø 225 x 12mm	3000K - 5000K
ROUND PANEL	27W	2700 Lm	AC 90-265V	120°	ø 300 x 12mm	3000K - 5000K
SQUARE PANEL	3W	300 Lm	AC 90-265V	120°	85 x 85 x 12mm	3000K - 5000K
SQUARE PANEL	6W	600 Lm	AC 90-265V	120°	120 x 120 x 12mm	3000K - 5000K
SQUARE PANEL	12W	1200 Lm	AC 90-265V	120°	170 x 170 x 12mm	3000K - 5000K
SQUARE PANEL	18W	1800 Lm	AC 90-265V	120°	225 x 225 x 12mm	3000K - 5000K
SQUARE PANEL	27W	2700 Lm	AC 90-265V	120°	300 x 300 x 12mm	3000K - 5000K

# LED CEILING LIGHTS



## GENERAL DESCRIPTION

LED CEILING LIGHTS VISIONAL perfectly suit for lighting at home, office, hospitals and etc. They provide instant full light, no flickering, high energy-efficiency and great brightness output. In addition, LED MODULE LIGHTS VISIONAL easily replace bulbs in old lamp fixtures, therefore it is possible to choose color of light and brightness.

# LED CEILING LIGHTS

## LED CEILING LAMP FIXTURE ROUND / SQUARE



## LED MODULE LIGHTS



MODEL MODELIS	POWER JAUDA	LUMEN OUTPUT GAISMAS PLUSMA	VOLTAGE SPRIEGUMS	BEAM ANGLE GAISMAS LENĶIS	DIMENSIONS IZMĒRI	CCT
LED Ceiling Lamp Fixture ROUND	12W	1200 Lm	AC 176~264V	120°	φ230mm	2700 - 6500K
LED Ceiling Lamp Fixture ROUND	18W	1800 Lm	AC 176~264V	120°	φ300mm	2700 - 6500K
LED Ceiling Lamp Fixture ROUND	24W	2400 Lm	AC 176~264V	120°	φ300mm	2700 - 6500K
LED Ceiling Lamp Fixture ROUND	36W	3600 Lm	AC 176~264V	120°	φ350mm	2700 - 6500K
LED Ceiling Lamp Fixture ROUND	54W	5400 Lm	AC 176~264V	120°	φ450mm	2700 - 6500K
LED Ceiling Lamp Fixture SQUARE	36W	3600 Lm	AC 176~264V	120°	300 x 300mm	2700 - 6500K
LED Ceiling Lamp Fixture SQUARE	56W	5600 Lm	AC 176~264V	120°	400 x 400mm	2700 - 6500K
LED Ceiling Lamp Fixture SQUARE	90W	9000 Lm	AC 176~264V	120°	500 x 500mm	2700 - 6500K
LED Module Lights VISIONAL	12W	1200 Lm	AC 220-240V	120°	110 x 110 x 20mm	3000 / 4000K
LED Module Lights VISIONAL	18W	1800 Lm	AC 220-240V	120°	145 x 145 x 20mm	3000 / 4000K
LED Module Lights VISIONAL	24W	2400 Lm	AC 220-240V	120°	160 x 160 x 20mm	3000 / 4000K
LED Module Lights VISIONAL	36W	3600 Lm	AC 220-240V	120°	210 x 210 x 20mm	3000 / 4000K

# LED CEILING LIGHTS WITH DIAMOND EFFECT



## GENERAL DESCRIPTION

LED CEILING LIGHTS VISIONAL perfectly suit for lighting at home, office, hospitals and etc. They provide instant full light, no flickering, high energy-efficiency and great brightness output. In addition, LED MODULE LIGHTS VISIONAL easily replace bulbs in old lamp fixtures, therefore it is possible to choose color of light and brightness.

# LED CEILING LIGHTS WITH DIAMOND EFFECT

## LED CEILING LAMP FIXTURE ROUND / SQUARE

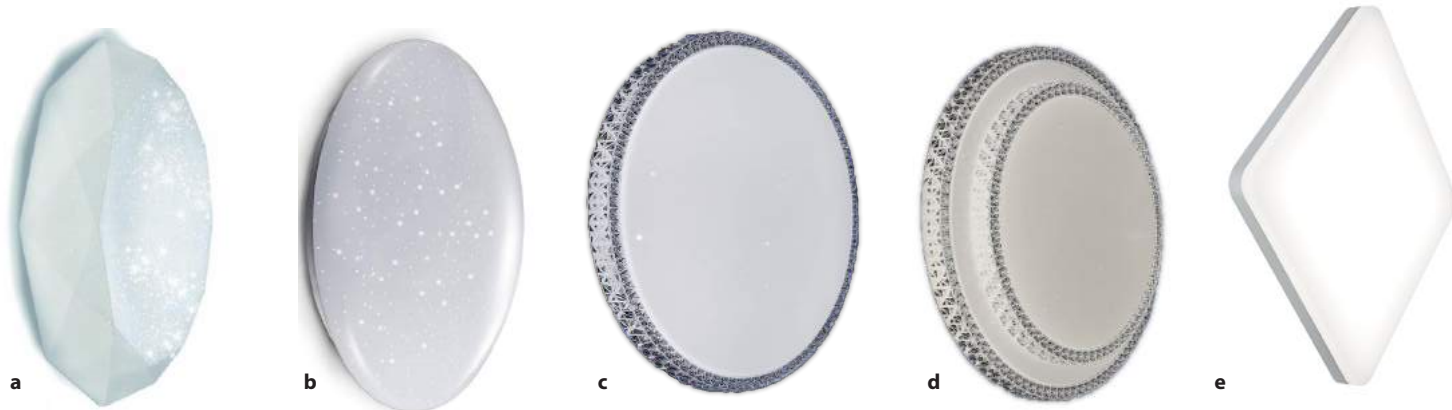

## LED MODULE LIGHTS

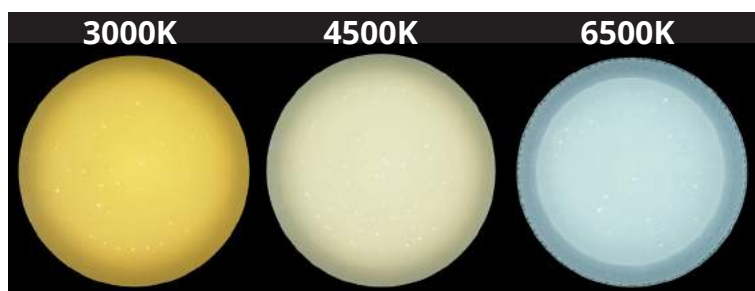
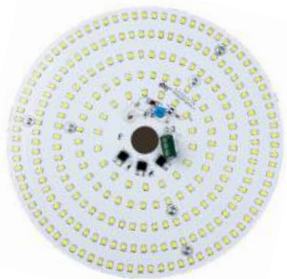

MODEL MODELIS	POWER JAUDA	LUMEN OUTPUT GAISMAS PLUSMA	VOLTAGE SPRIEGUMS	BEAM ANGLE GAISMAS LEŅĶIS	DIMENSIONS IZMĒRI	CCT
LED Ceiling Lamp ROUND	60W	6000 Lm	AC 176~264V	120°	Ø585*145 MM	3000 - 6500K
LED Ceiling Lamp ROUND	48W	4800 Lm	AC 176~264V	120°	Ø480*50 MM	3000 - 6500K
LED Ceiling Lamp ROUND	60W	6000 Lm	AC 176~264V	120°	Ø550*68 MM	3000 - 6500K
LED Ceiling Lamp ROUND	24W	2400 Lm	AC 176~264V	120°	Ø395*81MM	3000 - 6500K
LED Ceiling Lamp ROUND	48W	4800 Lm	AC 176~264V	120°	Ø496*94MM	3000 - 6500K
LED Ceiling Lamp ROUND	24W	2400 Lm	AC 176~264V	120°	Ø395*96MM	3000 - 6500K
LED Ceiling Lamp ROUND	48W	4800 Lm	AC 176~264V	120°	Ø496*103MM	3000 - 6500K
LED Ceiling Lamp SQUARE	60W	6000 Lm	AC 176~264V	120°	530*530*85MM	3000 - 6500K

# LED PLANT LIGHTING

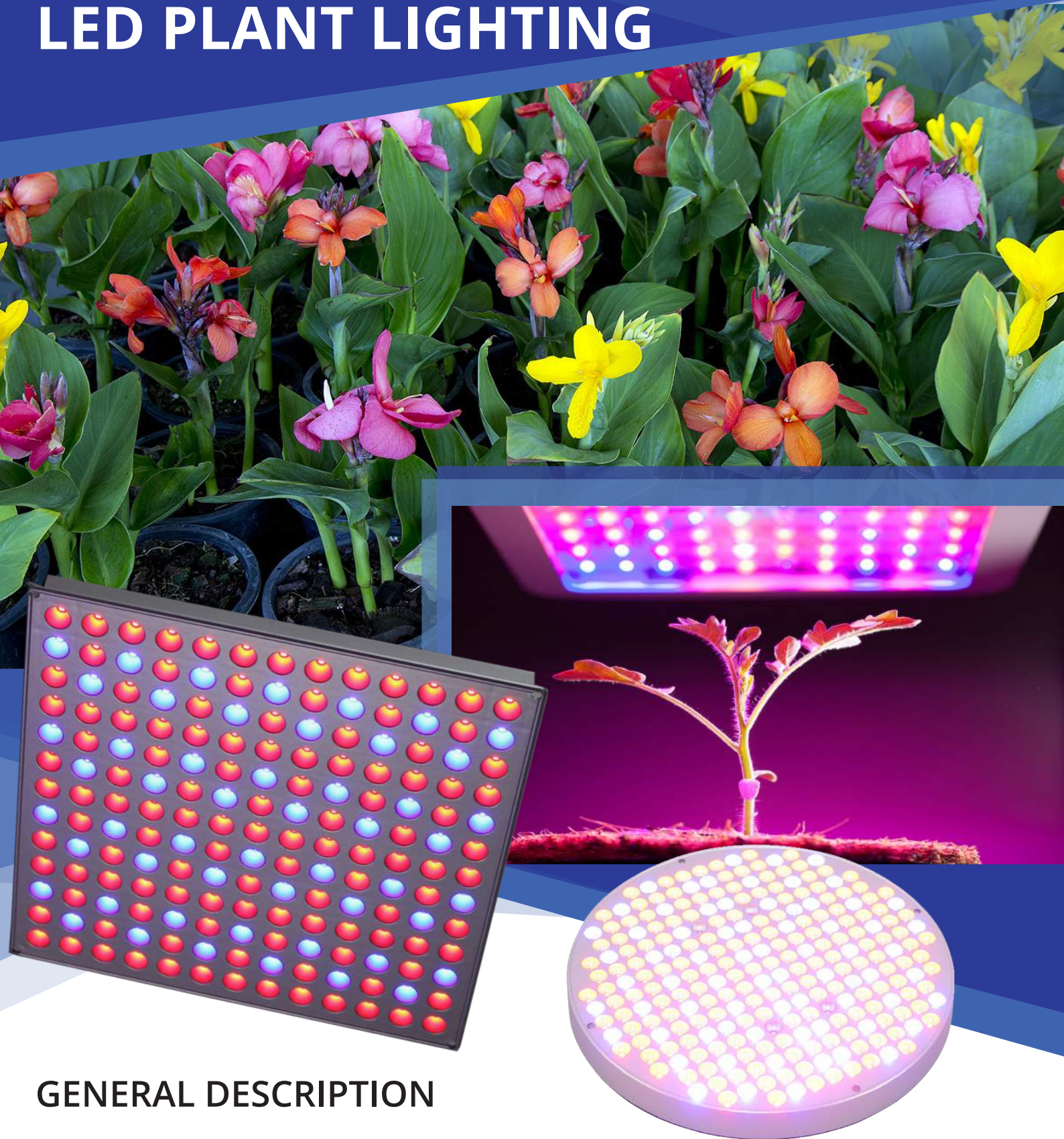

## GENERAL DESCRIPTION

LED Plant Lighting Grow lights are made of high quality materials for long lasting durability and dependability. Units provide an artificial light source designed to stimulate plant growth emitting an electromagnetic spectrum for photosynthesis. For use in applications without naturally occurring light or where supplemental light is required.

# LED PLANT LIGHTING

## LED PLANT LIGHTING / FITO LIGHT

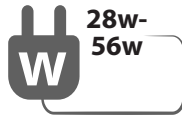
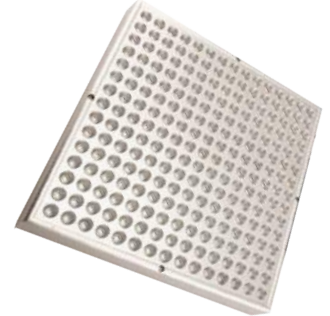

## INSTALLATION:

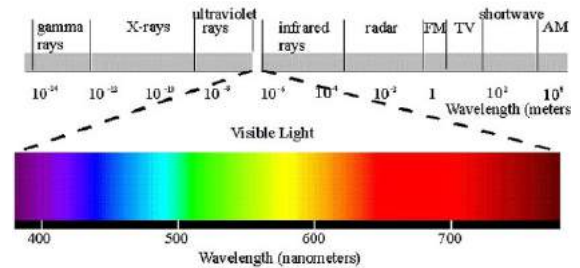
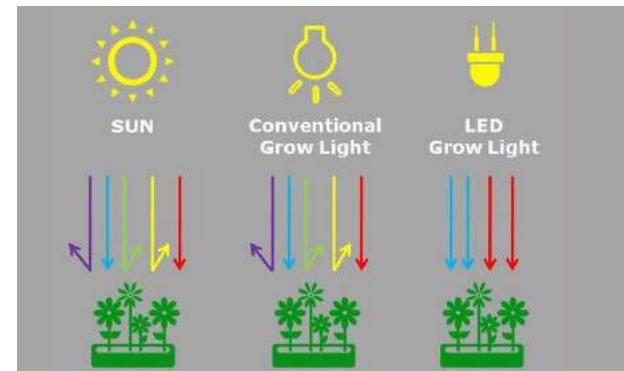

MODEL MODELIS	POWER JAUDA	LUMEN OUTPUT GAISMAS PLUSMA	VOLTAGE SPRIEGUMS	LIFETIME KALPOŠANAS ILGUMS	BEAM ANGLE GAISMAS LENĶIS	CCT
LED PLANT LIGHTING E27	12W	960 Lm	AC 220-240V	30000h	240°	UV
LED PLANT LIGHTING E27 FILAMENT	8W	640 Lm	AC 220-240V	30000h	180°	UV
LED PLANT LIGHTING RECTANGLE	28W	2240 Lm	AC 220-240V	30000h	180°	UV
LED PLANT LIGHTING CIRCLE	45W	3600 Lm	AC 85-300V	30000h	180°	UV
LED PLANT LIGHTING SQUARE	50W	4000 Lm	AC 175-265V	30000h	180°	UV
LED PLANT LIGHTING rectangle	56W	4480 Lm	AC 175-265V	30000h	180°	UV

# LED OUTDOOR LIGHTS



## GARDEN LIGHTS



50cm  
S-2918

80cm  
S-2919

50cm  
S-2915

80cm  
S-2916

**VISIONAL** LED PREMIUM



## GENERAL DESCRIPTION

Modern and stylish outdoor lighting solution. LED Landscape lights or garden lights VISIONAL refers to the use of outdoor illumination of private gardens or public landscapes. LED wall lighting VISIONAL makes your house more elegant and will improve the atmosphere as a whole. VISIONAL LED OUTDOOR LIGHTS is the best choice for lighting your house and garden.



## OUTDOOR WALL LIGHTS ✓RoHS CE



L-008



L-007



L-009



L-306B



L-002



L-010



L-001



L-002

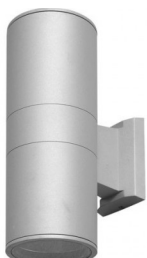

L-004



L-014



L-011



L-006



L-3305B



L-005



L-013



# LED OUTDOOR LIGHTS



**VISIONAL** <sup>®</sup> **LED**  
PREMIUM

MODEL MODELIS	BASE / POWER COKOLS / JAUDA	MATERIAL MATERIĀLS	VOLTAGE SPRIEGUMS	IP LEVEL MITRUMIZTURĪBA	DIMENSIONS IZMĒRI
<b>GARDEN LIGHTS</b>					
S-2915	E27	PLASTIC / METAL	AC 220-240V	IP65	500 x 120 mm
S-2916	E27	PLASTIC / METAL	AC 220-240V	IP65	800 x 120 mm
S-2918	E27	PLASTIC / METAL	AC 220-240V	IP65	500 x 177 mm
S-2919	E27	PLASTIC / METAL	AC 220-240V	IP65	800 x 177 mm
<b>OUTDOOR WALL LIGHTS</b>					
3306B	GU10	GLASS / METAL	AC 220-240V	IP44	110x160x105 mm
3305B	GU10	GLASS / METAL	AC 220-240V	IP44	100x160x105 mm
L-003	GU10 max 60Wx2	GLASS / METAL	AC 220-240V	IP54	110x240x125 mm
L-002	GU10 max 60Wx2	GLASS / METAL	AC 220-240V	IP54	110x240x105 mm
L-001	GU10 max 60Wx2	GLASS / METAL	AC 220-240V	IP54	110x240x105 mm
L-006	GU10 max 60Wx2	GLASS / METAL	AC 220-240V	IP54	110x260x150 mm
L-007	GU10 max 60Wx2	GLASS / METAL	AC 220-240V	IP54	110x260x150 mm
L-005	GU10 max 60Wx2	GLASS / METAL	AC 220-240V	IP54	110x280x105 mm
L-008	3Wx2	GLASS / METAL	AC 85-265V	IP65	170x80 mm
L-009	12W	GLASS / METAL	AC 85-265V	IP54	190x190 mm
L-010	GU10 max 60Wx2	GLASS / METAL	AC 220-240V	IP54	110x240x105 mm
L-002	GU10 max 60Wx2	GLASS / METAL	AC 220-240V	IP54	110x260x150 mm
L-004	GU10 max 60Wx2	GLASS / METAL	AC 220-240V	IP54	110x260x150 mm
L-013	GU10 max 60Wx2	GLASS / METAL	AC 220-240V	IP54	110x280x105 mm

# ALUMINIUM PROFILE

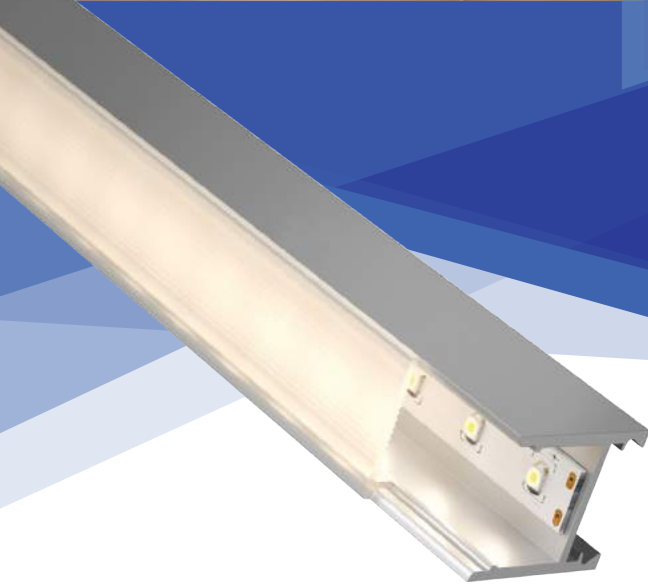

## GENERAL DESCRIPTION

LED STRIP PROFILES VISIONAL are made of high quality anodized aluminum. The main benefit of ALUMINIUM PROFILES is the ability to dissipate heat, this helps to extend the lifetime of LED flexible strips. They are easily fixed on ceiling, floors, in corners or other surfaces. LED STRIP PROFILES diffuse light, which creates unique and stylish design.

**VISIONAL** **LED**  
PREMIUM

# ALUMINIUM PROFILE



05-500M

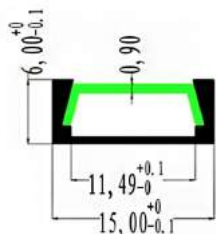

VS-P-001

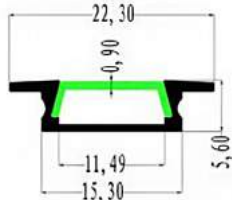

05-502

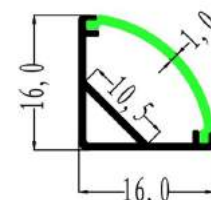

VS-P-007

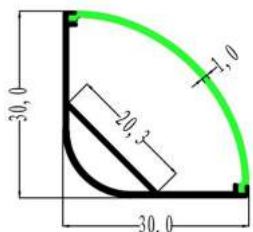

## BENDABLE ALUMINIUM PROFILE FOR LED STRIP LIGHTS



### ASSEMBLY SCHEME

1. Basic cover
2. LED strip
3. End cap without hole
- 3a. End cap with hole
4. Screw
5. Mini mounting clip for profile



# ALUMINIUM PROFILE

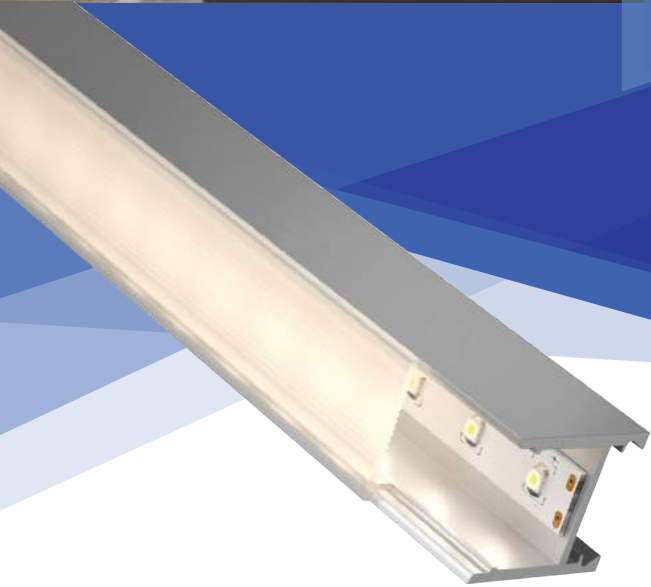
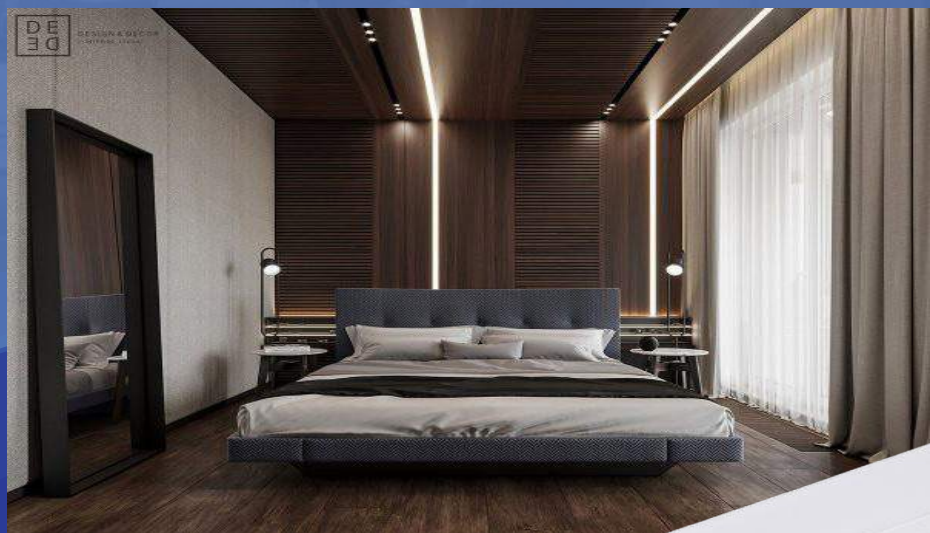

## GENERAL DESCRIPTION

LED STRIP PROFILES VISIONAL are made of high quality anodized aluminum. The main benefit of ALUMINIUM PROFILES is the ability to dissipate heat, this helps to extend the lifetime of LED flexible strips. They are easily fixed on ceiling, floors, in corners or other surfaces. LED STRIP PROFILES diffuse light, which creates unique and stylish design.

**VISIONAL** <sup>®</sup> **LED**  
**PREMIUM**

# ALUMINIUM PROFILE



05-504



05-508



05-510

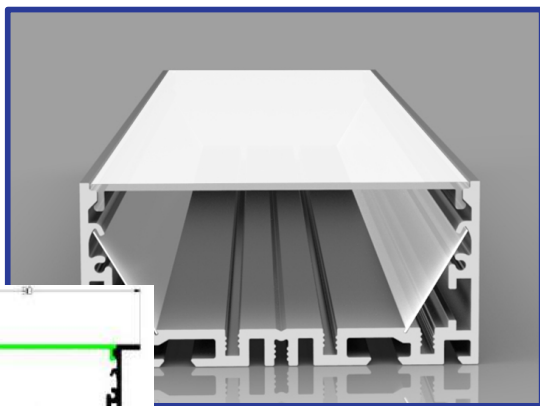
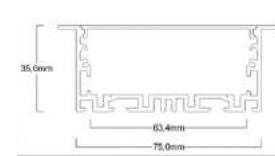
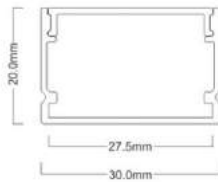
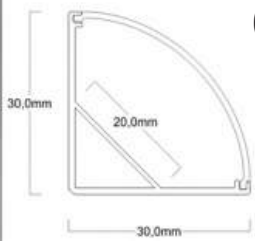

05-509

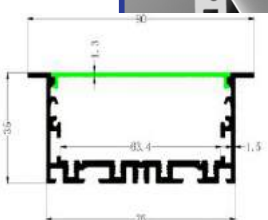

## ASSEMBLY SCHEME

1. Basic cover
2. LED strip
3. End cap without hole
- 3a. End cap with hole
4. Screw
5. Mini mounting clip for profile



# LED BULBS VISIONAL



## GENERAL DESCRIPTION

LED bulbs VISIONAL can easily replace old halogen bulbs. LED SERIES 360 VISIONAL provide low energy consumption, which ensure up to 80% energy saving. Additional benefits of LED bulbs VISIONAL SERIES 360 are wider illumination angle, instant full light, improved lamp housing and low heat emission. Comparing to many other well-known brands VISIONAL bulbs are brighter and more efficient.

# LED BULBS VISIIONAL



WARM  
WHITE  
3000K



WARM  
WHITE  
3000K

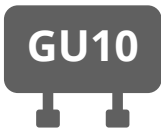

WARM  
WHITE  
3000K

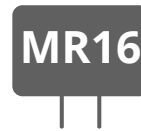

WARM  
WHITE  
3000K

MODEL MODELIS	POWER JAUDA	LUMEN GAISMAS PLUSMA	VOLTAGE SPRIEGUMS	BEAM ANGLE GAISMAS LEŅĶIS	DIMENSIONS IZMĒRI	CCT	LIFETIME KALPOŠANAS ILGUMS
E27 G45	6W	600 Lm	AC 85-265V	300°	45 x 75 mm	3000K	50000h
E27 C37	6W	570 Lm	AC 85-265V	270°	34 x 104 mm	3000K	50000h
E27 A60	7W	700 Lm	AC 85-265V	300°	60 x 110 mm	3000K	50000h
E27 A60	10W	1000 Lm	AC 85-265V	300°	60 x 110 mm	3000K	50000h
E27 A60	12W	1200 Lm	AC 85-265V	300°	60 x 119 mm	3000K	50000h
E27 A60	15W	1500 Lm	AC 85-265V	300°	70 x 122 mm	3000K	50000h
E27 R63	8W	800 Lm	AC 85-265V	200°	63 x 100 mm	3000K	50000h
E14 P45	6W	600 Lm	AC 85-265V	300°	45 x 75 mm	3000K	50000h
E14 R50	6W	600 Lm	AC 85-265V	200°	50 x 87 mm	3000K	50000h
E14 C37	4W	370 Lm	AC 85-265V	270°	34 x 105 mm	3000K	50000h
E14 C37	6W	540 Lm	AC 85-265V	270°	34 x 105 mm	3000K	50000h
GU10	5W	470 Lm	AC 85-265V	38°	49 x 59 mm	3000K	50000h
GU10	5W	470 Lm	AC 85-265V	120°	49 x 59 mm	3000K	50000h
MR16	5W	470 Lm	AC 85-265V	120°	49 x 59 mm	3000K	50000h

# LED BULBS VISIONAL



## GENERAL DESCRIPTION

VISIONAL brand offers wide range of high quality LED BULBS. Nowadays, it is possible to replace all types of old bulbs by LED. Filament series provide classic look of lamps for special design solutions, with high energy efficiency. LED VISIONAL G9 / G4 or R7S bulbs perfectly replace halogen models. In addition, VISIONAL RGB BULBS create stylish and modern lighting solutions.



# LED BULBS VISIONAL

## LED E40 BULBS



## LED BULBS G9 / G4

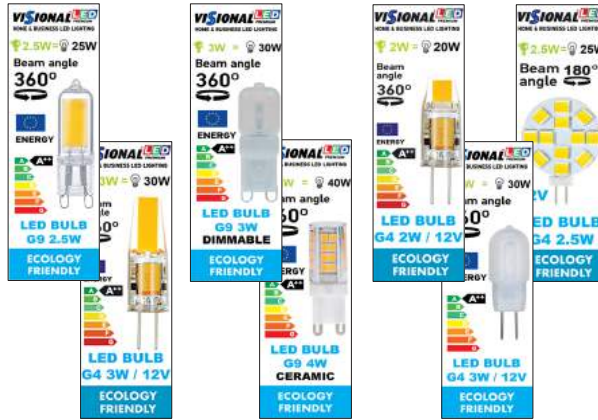

## LED BULBS R7S



## LED BULBS FILAMENT



LED BULB WITH REMOTE CONTROL RGB+WHITE

## LED BULB "FLAME EFFECT"



### 3 MODES

- 1. FLAME BREATH
- 2. FLAME
- 3. FULL LIGHT



MODEL MODELIS	POWER JAUDA	LUMEN GAISMAS PLUSMA	VOLTAGE SPRIEGUMS	BEAM ANGLE GAISMAS LEŅĶIS	DIMENSIONS IZMĒRI	LIFETIME KALPOŠANAS ILGUMS
E40 VISIONAL 360°	50W	4250 Lm	AC 100V - 260V	180°	Ø165 x 246mm	50000h
E40 VISIONAL 360°	100W	8500 Lm	AC 100V - 260V	180°	Ø220 x 320 mm	50000h
E40 VISIONAL 360°	50W	5000 Lm	AC 100V - 260V	200°	Ø160 x 215 mm	50000h
G9 VISIONAL 360°	2.5W	250 Lm	AC 85-265V	360°	13 x 48 mm	50000h
G9 VISIONAL 360°	3W	300 Lm	AC 85-265V	360°	17 x 12 x 48 mm	50000h
G9 VISIONAL 360°	4W	400 Lm	AC 85-265V	360°	14 x 53 mm	50000h
G4 VISIONAL 360°	1.5W	150 Lm	12V	360°	10 x 31 mm	50000h
G4 VISIONAL 360°	2W	200 Lm	12V	360°	10 x 31 mm	50000h
G4 12 LED VISIONAL 360°	2.5W	250 Lm	12V	180°	16 x 42 mm	50000h
G4 VISIONAL 360°	3W	300 Lm	12V	360°	16 x 12 x 45 mm	50000h
GX53 VISIONAL	7W	700 Lm	AC 85-265V	120°	75 x 24 mm	50000h
R7S VISIONAL	5W	500 Lm	AC 85-265V	360°	78 x 22 mm	50000h
R7S VISIONAL	10W	1000 Lm	AC 85-265V	360°	118 x 22 mm	50000h
R7S VISIONAL	12W	1200 Lm	AC 85-265V	360°	135 x 22mm	50000h
R7S VISIONAL	15W	1500 Lm	AC 85-265V	360°	189 x 22 mm	50000h

# LED BULBS FILAMENT VISIONAL



## LED BULBS FILAMENT

## EDISON STYLE LED BULBS FILAMENT



## EXCLUSIVE 3D LED BULBS FILAMENT



# LED BULBS FILAMENT VISIONAL



MODEL MODELIS	POWER JAUDA	LUMEN GAISMAS PLUSMA	VOLTAGE SPRIEGUMS	BEAM ANGLE GAISMAS LENĶIS	DIMENSIONS IZMĒRI	LIFETIME KALPOŠANAS ILGUMS
E27 G45 FILAMENT VISIONAL	4W	470 Lm	AC 85-265V	330°	45 x 82 mm	50000h
E27 G45 FILAMENT VISIONAL	6W	720 Lm	AC 85-265V	330°	45 x 82 mm	50000h
E27 A60 FILAMENT VISIONAL DIM	4W	450 Lm	AC 85-265V	300°	60 x 105 mm	50000h
E27 A60 FILAMENT VISIONAL DIM	8W	650 Lm	AC 85-265V	330°	60 x 105 mm	50000h
E27 A60 FILAMENT VISIONAL DIM	8W	960 Lm	AC 85-265V	330°	60 x 107 mm	50000h
E27 G80 FILAMENT VISIONAL DIM	6W	720 Lm	AC 85-265V	330°	80 x 120 mm	50000h
E27 T30-128 FILAMENT VISIONAL DIM	6W	720 Lm	AC 85-265V	330°	145 x 4 mm	50000h
E27 A60 FILAMENT VISIONAL DIM	10W	810 Lm	AC 85-265V	360°	60 x 105 mm	50000h
E27 ST64 FILAMENT VISIONAL DIM	6W	720 Lm	AC 85-265V	360°	125 x 80 mm	50000h
E27 G95 FILAMENT VISIONAL DIM	6W	720 Lm	AC 85-265V	360°	93 x 123 mm	50000h
E27 T30-225 FILAMENT VISIONAL DIM	8W	960 Lm	AC 85-265V	360°	30 x 225 mm	50000h
E27 ST64 FILAMENT VISIONAL DIM	8W	960 Lm	AC 85-265V	360°	64 x 145 mm	50000h
E27 G95 FILAMENT VISIONAL DIM	8W	960 Lm	AC 85-265V	360°	95 x 140 mm	50000h
E27 A60 FILAMENT VISIONAL	12W	1055 Lm	AC 85-265V	360°	60 x 105 mm	50000h
E27 T30-185 FILAMENT VISIONAL DIM	6W	720 Lm	AC 85-265V	360°	30 x 185 mm	50000h
E27 T30-300 FILAMENT VISIONAL DIM	12W	1440Lm	AC 85-265V	360°	30 x 300 mm	50000h
E27 G125 FILAMENT VISIONAL DIM	10W	1200 Lm	AC 85-265V	360°	125 x 150 mm	50000h
E27 ST64 FILAMENT VISIONAL 3D	3W	200 Lm	AC 85-265V	360°	64 x 136 mm	50000h
E27 D120 FILAMENT VISIONAL	10W	1200 Lm	AC 85-265V	360°	110 x 145 mm	50000h
E27 ST64 FILAMENT VISIONAL 3D	3W	200 Lm	AC 85-265V	360°	64 x 145 mm	50000h
E27 G125 FILAMENT VISIONAL 3D	3W	200 Lm	AC 85-265V	360°	125 x 150 mm	50000h
E27 5S125 FILAMENT VISIONAL 3D	3W	200 Lm	AC 85-265V	360°	140 x 170 mm	50000h
E27 CT125 FILAMENT VISIONAL DIM	3W	200 Lm	AC 85-265V	360°	220 x 65 mm	50000h
E14 FILAMENT VISIONAL DIM	4W	470 Lm	AC 85-265V	360°	37 x 99 mm	50000h
E14 P45 FILAMENT VISIONAL DIM	2W	250 Lm	AC 85-265V	360°	37 x 99 mm	50000h
E14 P45 FILAMENT VISIONAL DIM	4W	470 Lm	AC 85-265V	360°	45 x 82 mm	50000h
E14 FILAMENT VISIONAL DIM	2W	250 Lm	AC 85-265V	360°	45 x 82 mm	50000h

# LED STRIP VISIONAL



## GENERAL DESCRIPTION

LED STRIPS VISIONAL offer variety of types, colors and brightness. LED strips are used to create elegant interior design or lighting accents. LED HIGH POWER STRIP VISIONAL is a perfect solution to emphasize architecture of any building. High lumen output, long lifetime, high quality materials and reasonable price differ LED STRIPS VISIONAL on the market.

# LED STRIP VISIONAL

## LED HIGH POWER STRIP 220V

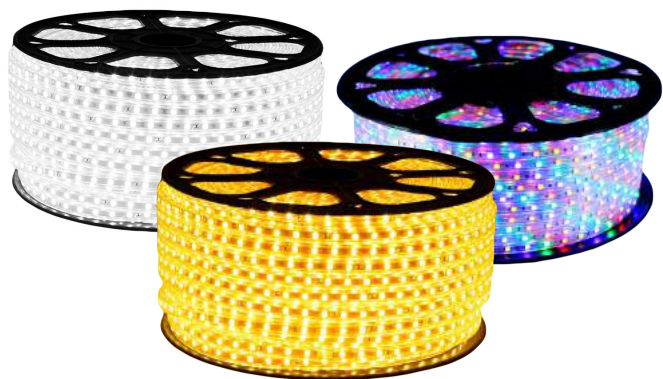

## LED ROPE LIGHT 220V



\*AC/DC CONNECTOR ONLY



MODELIS MODEL	POWER JAUDA	LUMEN OUTPUT GAISMAS PLUSMA	VOLTAGE SPRIEGUMS	BEAM ANGLE GAISMAVS LEŅĶIS	LED PER METER LED PĒC METRĀ	CCT	PROTECTION LEVEL AIZSARDĪBAS LĪMENIS
LED strip 3528	4.8W/m	360 Lm	220V AC (CONNECTOR)	130°	60 LED/m	CW/NW/WW/RGB	IP65
LED strip 5050	14.4W/m	1080 Lm	220V AC (CONNECTOR)	130°	60 LED/m	CW/NW/WW/RGB	IP65
LED DURALIGHT	2.16W/m	WWW	220V AC (CONNECTOR)	130°	36 LED/m	RGB	IP65
LED DURALIGHT	2.16W/m	WWW	220V AC (CONNECTOR)	130°	36 LED/m	CW/NW/WW/RGB	IP65
LED strip 5050	14.4W/m	1080 Lm	12V DC	130°	60 LED/m	CW/NW/WW/RGB	IP68 (WATERPROOF)
LED strip 3528	4.8W/m	420 Lm	12V DC	130°	60 LED/m	CW/NW/WW/RGB	IP20/IP65
LED strip 3528	9.6W/m	840 Lm	12V DC	130°	120 LED/m	CW/NW/WW/RGB	IP20/IP65
LED strip 2835	14.4W /m	1440 Lm	12V DC	130°	60 LED/m	CW/NW/WW/RGB	IP20/IP65
LED strip 2835	28.8W/m	288 Lm	12V DC	130°	120 LED/m	CW/NW/WW/RGB	IP20/IP65
LED strip 5050	7.2W/m	540 Lm	12V DC	130°	30 LED/m	CW/NW/WW/RGB	IP20/IP65
LED strip 5050	14.4W/m	1080 Lm	12V DC	130°	60 LED/m	CW/NW/WW/RGB	IP20/IP65
LED strip 5050	17.2W/m	1080 Lm	12V DC	130°	60 LED/m	4 in 1 - RGBW	IP20
LED strip 3014	5.8W/m	840 Lm	12V DC	130°	60 LED/m	CW/NW/WW/RGB	IP20/IP65
LED strip 3014	11.6W/m	1680 Lm	12V DC	130°	120 LED/m	CW/NW/WW/RGB	IP20/IP65
LED strip 3014	23.2W/m	3360 Lm	12V DC	130°	240 LED/m	CW/NW/WW/RGB	IP20/IP65

# LED CHRISTMAS LIGHTS

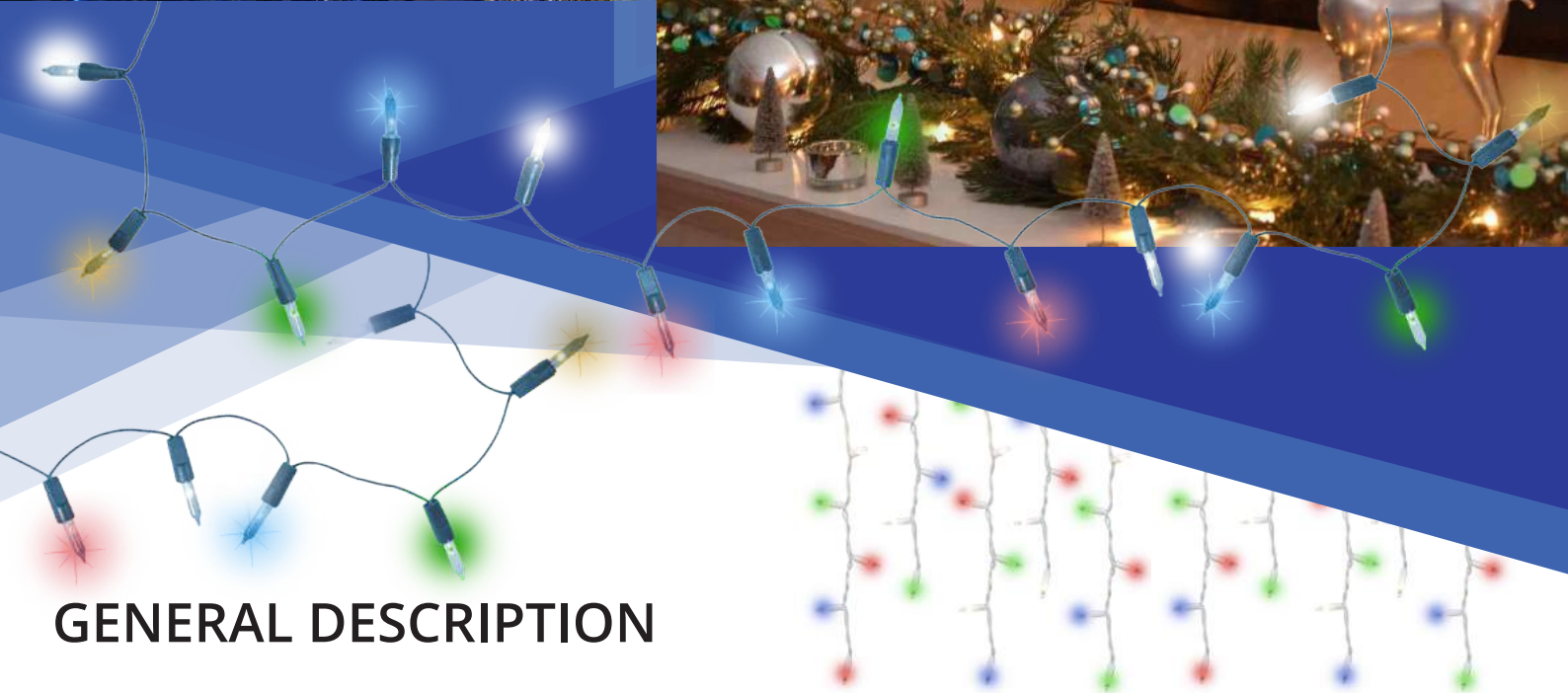

## GENERAL DESCRIPTION

LED CHRISTMAS LIGHTS VISIONAL creates a unique fabulous Christmas atmosphere for both indoor and outdoor areas. The high quality of VISIONAL products will add brightness to your holidays for many years. Wide range of LED CHRISTMAS LIGHTS VISIONAL perfectly suits for private and commercial sector.

Let us create holiday magic together.

**VISIONAL** **LED**  
PREMIUM

# LED CHRISTMAS LIGHTS

## STRING LIGHT



- BULB HOLDERS
- IN LINE / HANGING
- PROTECTION LEVEL IP68
- FOR E27 BULBS
- FOR 220 VOLTAGE

## LED CHRISTMAS LIGHTS



- LENGTH: 5 / 10 / 30m
- LED QUANTITY: 50-300
- COLOR: CW, WW, W, RGB
- IP LEVEL: IP44
- VOLTAGE: 220V / 12V (BATTERIES)



## LED ICICLE LIGHTS



- COLOR: CW, WW, W,RGB
- LENGTH: 5 - 300 m
- HEIGHT: 0.5 - 3 m
- IP LEVEL: IP44 / IP65
- VOLTAGE: 220V

## LED CURTAINS



- COLOR: CW, W, RGB
- LENGTH: 3.6 - 36 m
- HEIGHT: 30 / 50 / 80 cm
- IP LEVEL: IP44 / IP65
- VOLTAGE: 220V



## LED LASER PROJECTOR



- COLOR: CW, WW, W+RGB
- IP LEVEL: IP44 / IP65
- MATERIAL: METAL
- DISTANCE: up to 15 m
- VOLTAGE: 100-240V

## LED METEOR LIGHTS

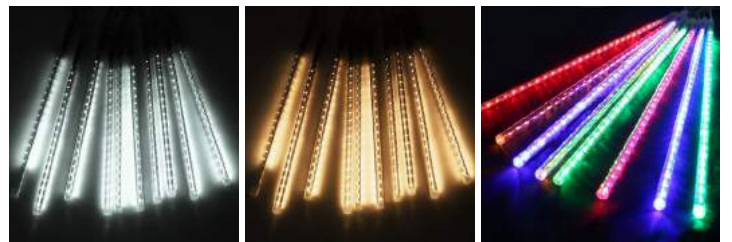

- COLOR: CW, WW, W, RGB
- LENGTH: 3.6 - 36 m
- HEIGHT: 30 / 50 / 80 cm
- IP LEVEL: IP44 / IP65
- VOLTAGE: 220V



# STRING LIGHT

## HANGING BLACK/ WHITE 5M



- 5 BULB HOLDERS
- SOCKET SPACING 70 CM
- PROTECTION LEVEL IP68
- FOR E27 BULBS
- FOR 220 VOLTAGE



## HANGING BLACK/ WHITE 15M



- 18 BULB HOLDERS
- SOCKET SPACING 70 CM
- PROTECTION LEVEL IP68
- FOR E27 BULBS
- FOR 220 VOLTAGE



## HANGING BLACK/ WHITE 100M



- 109 BULB HOLDERS
- SOCKET SPACING 90 CM
- PROTECTION LEVEL IP68
- FOR E27 BULBS
- FOR 220 VOLTAGE





# STRING LIGHT

## IN LINE BLACK/ WHITE 5M



- 5 BULB HOLDERS
- SOCKET SPACING 70 CM
- PROTECTION LEVEL IP68
- FOR E27 BULBS
- FOR 220 VOLTAGE

## IN LINE BLACK/ WHITE 15M

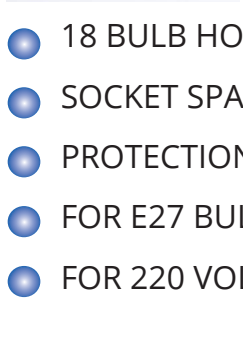

- 18 BULB HOLDERS
- SOCKET SPACING 70 CM
- PROTECTION LEVEL IP68
- FOR E27 BULBS
- FOR 220 VOLTAGE



## IN LINE BLACK 20M



- 25 BULB HOLDERS
- SOCKET SPACING 70 CM
- PROTECTION LEVEL IP68
- FOR E27 BULBS
- FOR 220 VOLTAGE

## IN LINE BLACK 50M



- 68 BULB HOLDERS
- SOCKET SPACING 70 CM
- PROTECTION LEVEL IP68
- FOR E27 BULBS
- FOR 220 VOLTAGE



## IN LINE BLACK/ WHITE 100M



- 109 BULB HOLDERS
- SOCKET SPACING 90 CM
- PROTECTION LEVEL IP68
- FOR E27 BULBS
- FOR 220 VOLTAGE



# LED COTTON BALLS



# LED COTTON BALLS

## WHITE SNOW



- MATERIAL: COTTON
- DIAMETER: 6 / 8 cm
- SET: 20 pcs
- WHITE COLOR
- VOLTAGE: 220V / 12V (BATTERY)

## CASPIAN SEA



- MATERIAL: COTTON
- DIAMETER: 6 cm
- SET: 20 pcs
- 3 COLORS
- VOLTAGE: 220V / 12V (BATTERY)

## DARK CHOCOLATE



- MATERIAL: COTTON
- DIAMETER: 6 / 8 cm
- SET: 20 pcs
- WHITE COLOR
- VOLTAGE: 220V / 12V (BATTERY)

## VINTAGE



- MATERIAL: COTTON
- DIAMETER: 6/8 cm
- SET: 20 pcs
- 3 COLORS
- VOLTAGE: 220V / 12V (BATTERY)

## LOLLIPOP



- MATERIAL: COTTON
- DIAMETER: 6 cm
- SET: 20 pcs
- WHITE COLOR
- VOLTAGE: 220V / 12V (BATTERY)

## FLAMINGO



- MATERIAL: COTTON
- DIAMETER: 6 cm
- SET: 20 pcs
- 3 COLORS
- VOLTAGE: 220V / 12V (BATTERY)

# OUR PROJECTS

## RIGA CENTRAL TERMINAL



**"RIX" - WAREHOUSE**



**"TOTALS" FILLING STATION**



## "MĒNESS" PHARMACY



**"VARPU" TENNIS CLUB**



**"MĒBEĻU NAMS" SHOP**



# OUR PROJECTS

## “IZOTERMS” INDUSTRIAL COMPLEX: STREET LIGHTNING



## “VEF” CULTURE PALACE

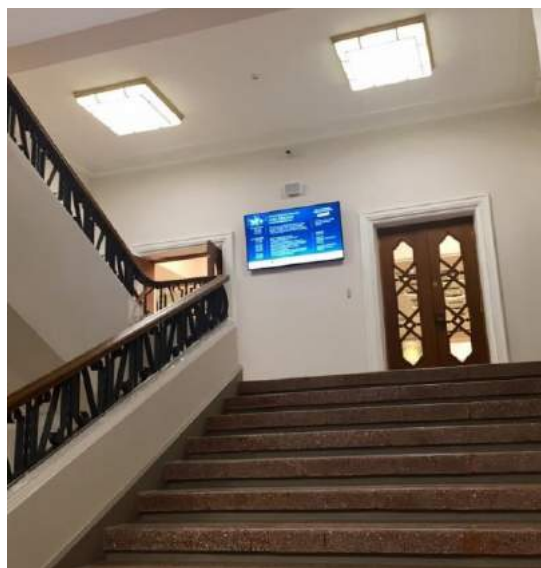

## “IZOTERMS” WAREHOUSE LIGHTNING



## “MEGO” WAREHOUSE



# OUR PROJECTS

## FREERPORT OF RIGA



## EAST METAL



## "STOCKMANN" SHOPPING CENTER



## "LEX interior" SHOPPING CENTER



# OUR PROJECTS

**"MUCA" CAFE**



**"ILLU ZION" RESTARAUNT**



**"BITE" SHOP**



**"TEZ TOUR" TRAVEL AGENCY**



**"PAPRIKA" CARWASH**



**"IZOTERMS" WAREHOUSE**



**"IZOTERMS" OFFICE**



**"SWH" OFFICE LIGHTNING**



# OUR PROJECTS

**FORNITURE SHOP**



**"CITA SANTEHNIKA" SHOP**



**ARMENIA RESTAURANT**



**"CHICCO" SHOP**



**"EHRLE" WAREHOUSE**



**"DIENA" OFFICE**

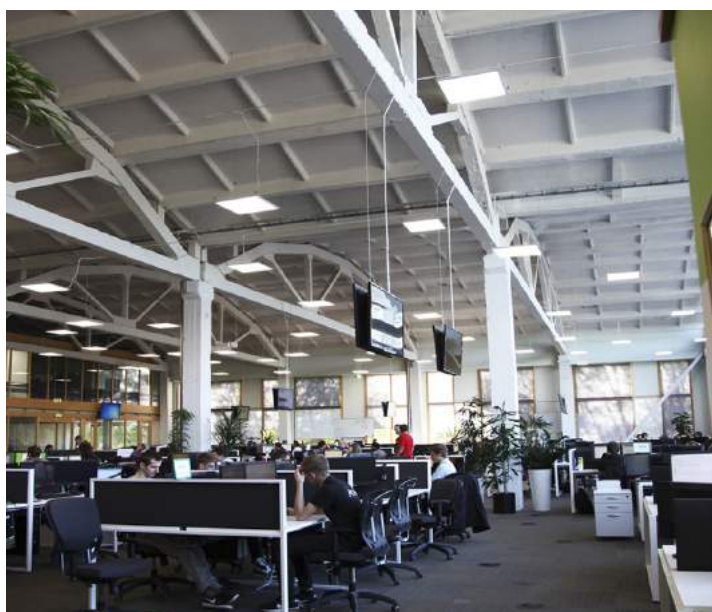



# OUR PROJECTS

**"BETA" SHOP**



**"TYTAN" FITNESS CENTER**



**"GLOBAL FITNESS" GYM**



**"CAN CAN" PIZZERIA**

**"GAN BEI" RESTAURANT**

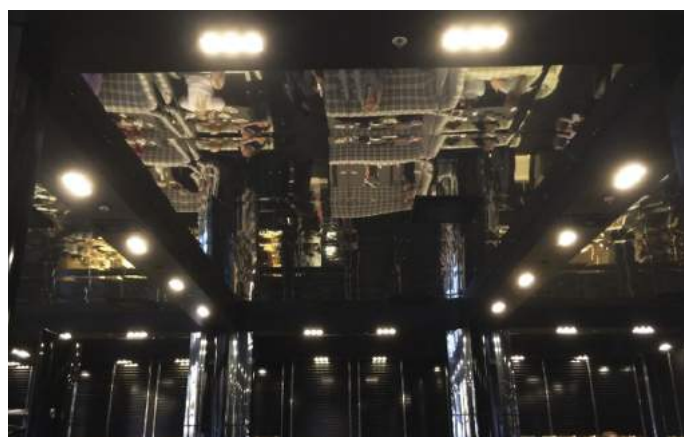
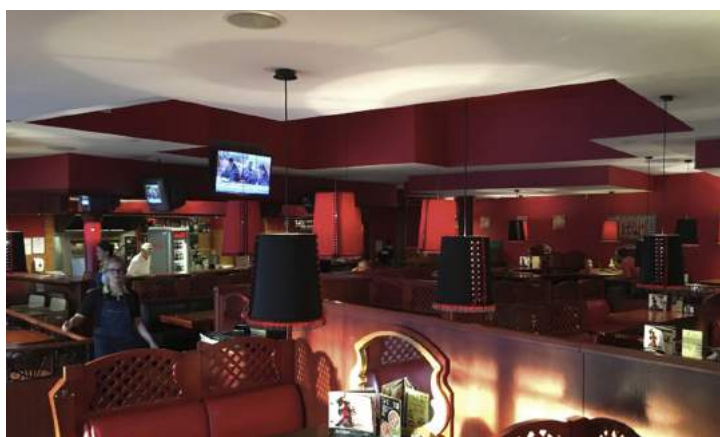

**CHRISTMAS LIGHTING**

**"OLYMPIC" CASINO**



# OUR PROJECTS

**"LATIO" BUILDING**



**"SKY-GARDEN" COMPLEX**



**LED 3D CELING**



**LATVIJAS FINIERIS**



**TALLINK BOARD**

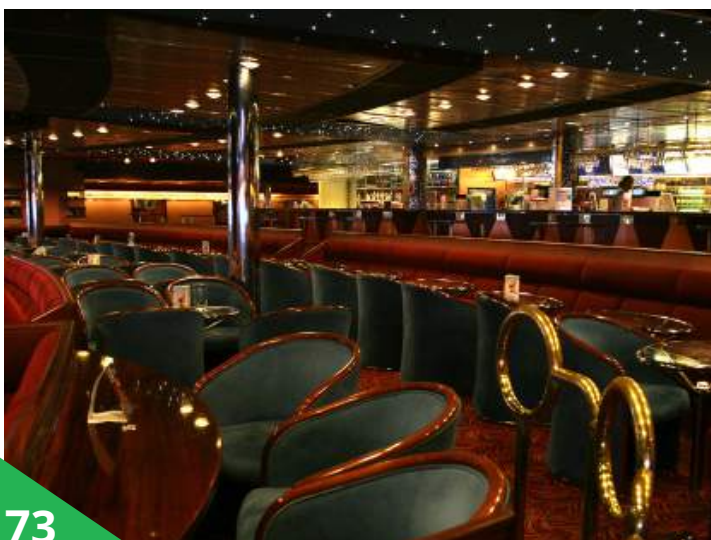

**"LATAKKO" OFFICE**

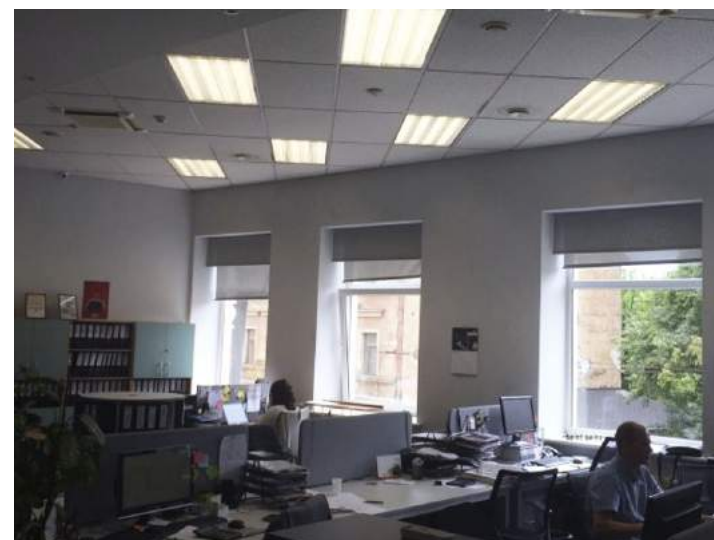

# OUR PROJECTS

**"CARWASH ERHLE"**



**"TUF" AUTOCENTER**



**"CARWASH ERHLE"**



**"ATLETIKA" FITNESS CENTER**



**"NEST STUDIO" SHOP**



**"CHICCO" SHOP**



# OUR PROJECTS

## "QUINTESSENCE" HAUTE PARFUMERIE SHOP

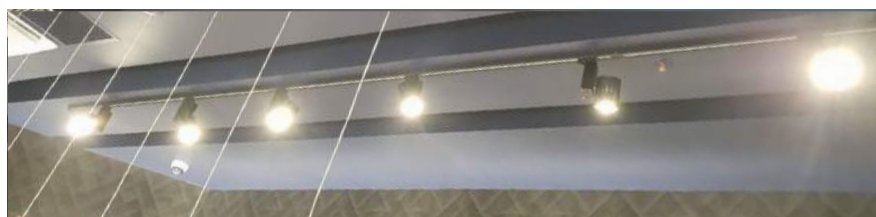

## "DROGAS" SHOP

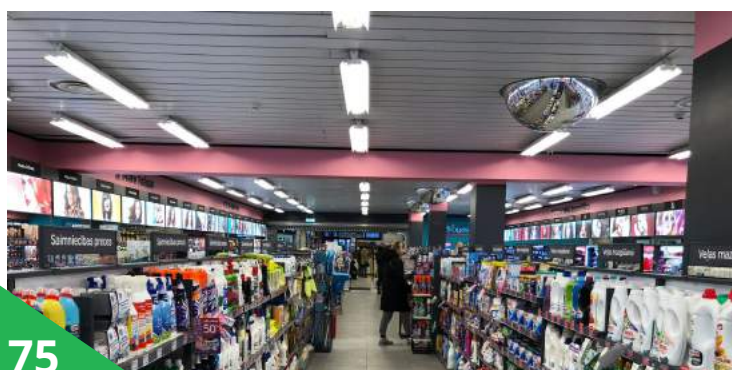
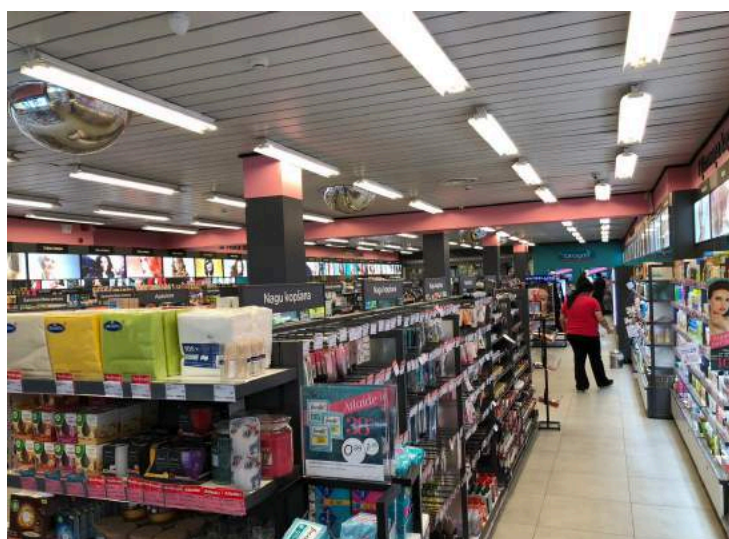

# OUR PROJECTS

## COSMETOLOGY CABINETS



## OFFICE LIGHTING



## "MEGO" SHOP



## JUNGHEINRICH, CERTEX, APE MOTORS WAREHOUSES

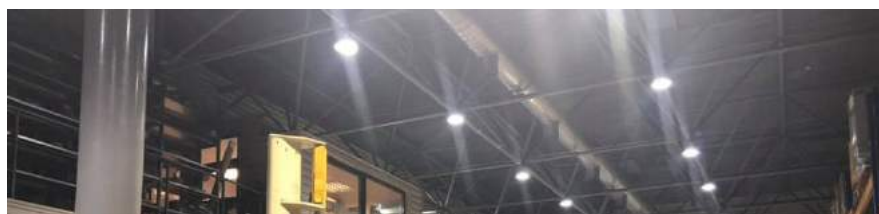
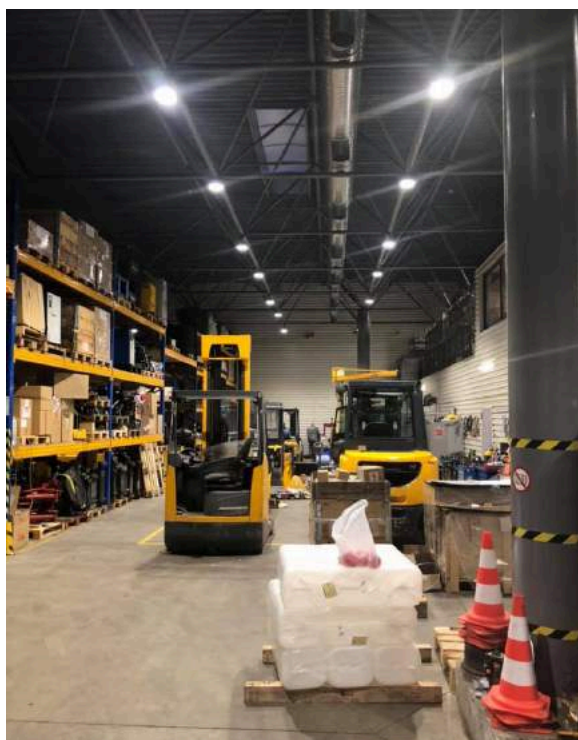

# OUR PROJECTS

## OLYMPIC CENTER JELGAVA

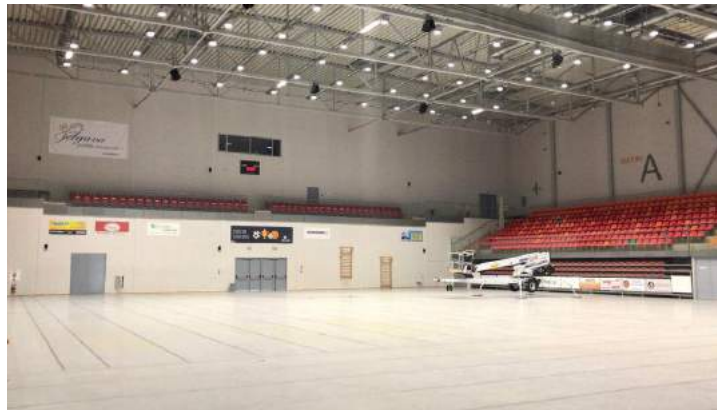
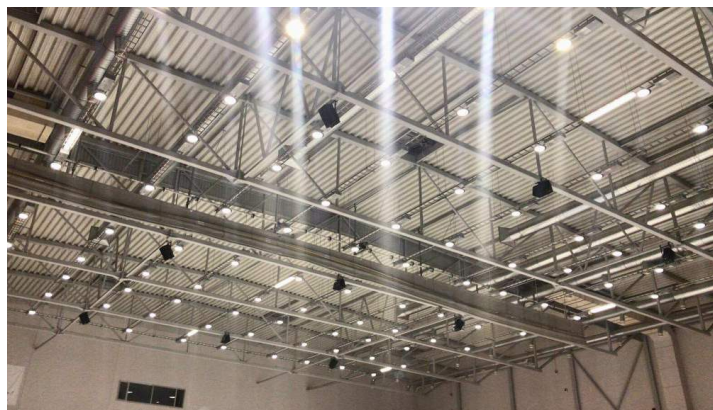

## RD ELECTRONICS SHOP AKROPOLE LATVIA



## XS ROTAĻĻIETAS AKROPOLE LATVIA



# OUR PROJECTS

## RD ELECTRONICS SHOP

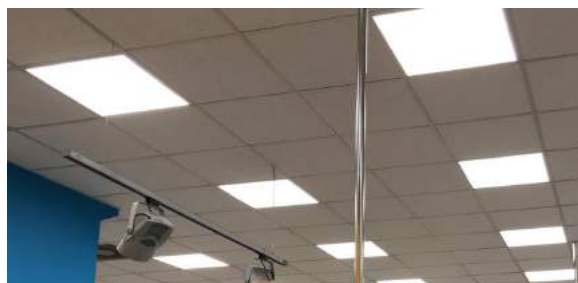
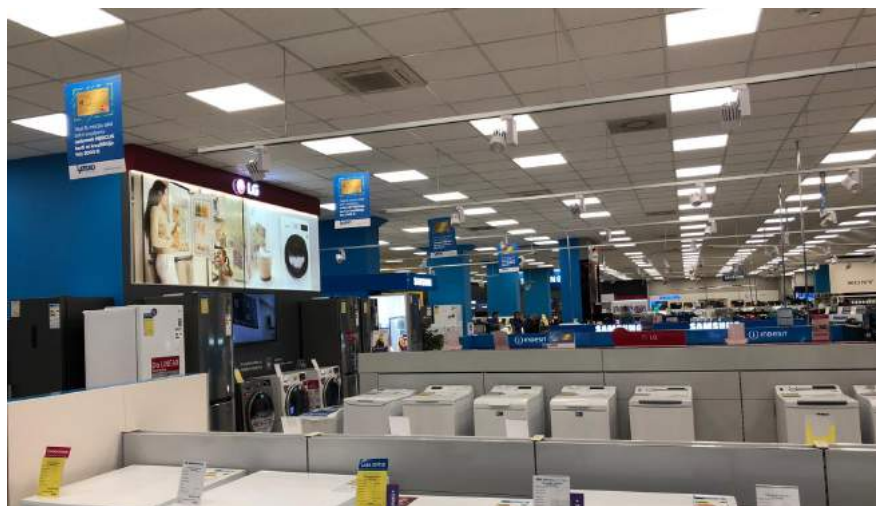

# EUR LED.LV

EUROPEAN LED COMPANY



**We are looking forward to long-term cooperation!**

## **Addresses:**

13, Katlakalna str. Riga, Latvia  
129, A. Chaka str., Riga, Latvia  
148, Kalnciema str., Riga, Latvia

## **Contact us:**

+371 28 888 824  
info@euroled.lv  
www.euroled.lv